

Teladoc Health[®]

TV Pro 300[™]

User Guide



Model/HVIN: 20-20444

P/N: MA20250.C

© Teladoc Health, Inc. All rights reserved.

Teladoc[®]
HEALTH

Table of Contents

Copyrights	1
Safety Instructions	2
Electromagnetic Compatibility	7
Virtual Care System	13
Definition of “Device”	14
Before You Begin	15
Privacy Mode	33
Request a Virtual Nurse	34
Active Session Screen Navigation	39
Device Audio and Video Mute	40
TV Pro 300 Specifications	41
TV Pro 300 Performance Specifications	43
TV Pro 300 Input Power Specifications	44
Environmental Specifications	45
RF Power Rating and Frequencies	46
TV Pro 300 Electrical and Safety Test Standards	47
TV Pro 300 Troubleshooting	49
Device Cleaning	50
Contact Information	54

Copyrights

© Teladoc Health, Inc. All rights reserved. This manual contains information including, but not limited to, instructions, descriptions, definitions, firmware and software, which are proprietary to Teladoc Health. Copyright information is protected under Title 17 of the United States Code. This information shall not be copied, modified, or used in any manner that violates any rights of Teladoc Health. We will strictly enforce all of our rights.

Patent(s):

<https://teladochealth.com/patents/>

THIS SOFTWARE IS PROVIDED BY THE COPYRIGHT HOLDERS AND CONTRIBUTORS “AS IS” AND ANY EXPRESS OR IMPLIED WARRANTIES, INCLUDING, BUT NOT LIMITED TO, THE IMPLIED WARRANTIES OF MERCHANTABILITY AND FITNESS FOR A PARTICULAR PURPOSE ARE DISCLAIMED. IN NO EVENT SHALL THE FOUNDATION OR CONTRIBUTORS BE LIABLE FOR ANY DIRECT, INDIRECT, INCIDENTAL, SPECIAL, EXEMPLARY, OR CONSEQUENTIAL DAMAGES (INCLUDING, BUT NOT LIMITED TO, PROCUREMENT OF SUBSTITUTE GOODS OR SERVICES; LOSS OF USE, DATA, OR PROFITS; OR BUSINESS INTERRUPTION) HOWEVER CAUSED AND ON ANY THEORY OF LIABILITY, WHETHER IN CONTRACT, STRICT LIABILITY, OR TORT (INCLUDING NEGLIGENCE OR OTHERWISE) ARISING IN ANY WAY OUT OF THE USE OF THIS SOFTWARE, EVEN IF ADVISED OF THE POSSIBILITY OF SUCH DAMAGE.

Microsoft® and Windows® are either registered trademarks or trademarks of Microsoft Corporation in the U.S. and/or other countries.

Last updated: December 2023

Safety Instructions

Users of the system require clinical judgment and experience to review and interpret the patient data transmitted.

Notes, Cautions and Warnings

The types of safety instructions are:





NOTE: Supplementary information to facilitate the operation of the system.





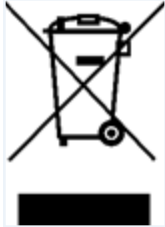

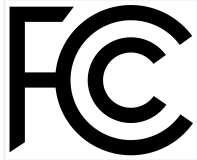
CAUTION: Instructions for avoiding damage to the system.

WARNING: Information may prove hazardous to the safety of a person near the Teladoc Health Patient Access device.

Safety Symbols

Symbols appearing on the Patient Access device and other equipment are defined in the table below.

<p>Wireless Transmitter Notification: Non-ionizing electromagnetic radiation. This device communicates over the 802.11 ac/a/b/g/n standard for wireless communication.</p>	
<p>Do Not Dispose of in Household Waste: This symbol explains that you should not place the electrical item in the general waste.</p>	
<p>The Regulatory Compliance Mark: The Australian Standard AS/NZS 4417.1 and AS/NZS 4417.2 Marking of electrical products to indicate compliance with regulations. General rules for use of the mark provides general requirements for the use of the RCM including location of the marking on the equipment and its dimensional requirements. The RCM is a symbol that represents compliance with two independent schemes: EESS; and ACMA's labelling requirements.</p>	
<p>FCC: The FCC mark is a voluntary mark employed on electronic products manufactured or sold in the United States which indicates that the electromagnetic radiation from the device is below the limits specified by the Federal Communications Commission and the manufacturer has followed the requirements of the Supplier's Declaration of Conformity authorization procedures.</p>	
<p>Date of Manufacturer: This symbol shall be accompanied by the name and address of the manufacturer.</p>	

<p>TUV Mark - This test mark is proof of compliance with Canadian National standards and U.S. National standards. It demonstrates an electrical product has been successfully tested and certified by a Certification Body accredited by the Standards Council of Canada (SCC) and by a Nationally Recognized Testing Laboratory (NRTL) accredited by the Occupational Safety and Health Administration (OSHA).</p>	
<p>Country of Manufacture: To identify the country of manufacture of products. CN = China as country of manufacture.</p>	
<p>Consult Operator's Manual: Operating Instructions are contained in a separate instruction manual.</p>	
<p>CE Label: On commercial products, the letters CE mean that the manufacturer or importer affirms the good's conformity with European health, safety and environmental protection standards.</p>	
<p>UKCA Label: The UKCA marking is the product marking used for products being placed on the market in Great Britain (England, Scotland and Wales).</p>	
<p>Proposition 65: State of California: The law requires California to publish a list of chemicals known to cause cancer or reproductive toxicity, and for businesses with 10 or more employees to provide warnings when they knowingly and intentionally cause significant exposures to listed chemicals.</p> <div data-bbox="94 1140 1089 1276" style="border: 1px solid black; padding: 5px;">  <p>WARNING: This product can expose you to chemicals including Diisononyl Phthalate, which is known to the State of California to cause cancer, and Bisphenol A, which is known to the State of California to cause birth defects or other reproductive harm. For more information go to www.P65Warnings.ca.gov.</p> </div>	

FCC Warning

WARNINGS:

- This equipment has been tested and found to comply with the limits for a Class A digital device, pursuant to part 15 of the FCC Rules. These limits are designed to provide reasonable protection against harmful interference when the equipment is operated in a commercial environment. This equipment generates, uses and can radiate radio frequency energy and, if not installed and used in accordance with the instruction manual, may cause harmful interference to radio communications. Operation of this equipment in a residential area is likely to cause harmful

interference in which case the user will be required to correct the interference at their own expense.

Cet équipement a été testé et déclaré conforme aux limites d'un appareil numérique de classe A, conformément à la partie 15 des règles de la FCC. Ces limites sont conçues pour fournir une protection raisonnable contre les interférences nuisibles lorsque l'équipement est utilisé dans un environnement commercial. Cet équipement génère, utilise et peut émettre de l'énergie de fréquence radio et, s'il n'est pas installé et utilisé conformément au manuel d'instructions, peut causer des interférences nuisibles aux communications radio. L'utilisation de cet équipement dans une zone résidentielle est susceptible de provoquer des interférences nuisibles, auquel cas l'utilisateur devra corriger les interférences à ses propres frais.

- The device supports the 5 GHz U-NII 1 frequency band, which is 5.150 to 5.250 GHz. It will be restricted for use in the indoor environment only.

L'appareil prend en charge la bande de fréquences 5 GHz U-NII 1, qui est de 5,150 à 5,250 GHz. Il sera limité à une utilisation dans un environnement intérieur uniquement.

- Telehealth Communications system should be installed and operated with minimum distance of 20 cm between the radiator and your body.

Le système de communication de télésanté doit être installé et utilisé à une distance minimale de 20 cm entre le radiateur et votre corps.

- The device complies with part 15 of the FCC Rules. Operation is subject to the following two conditions: (1) This device may not cause harmful interference, and (2) this device must accept any interference received, including interference that may cause undesired operation.

L'appareil est conforme à la partie 15 des règles de la FCC. Le fonctionnement est soumis aux deux conditions suivantes : (1) cet appareil ne doit pas causer d'interférences nuisibles et (2) cet appareil doit accepter toute interférence reçue, y compris les interférences susceptibles de provoquer un fonctionnement indésirable.

- **MODIFICATION:** Any changes or modifications not expressly approved by the grantee of this device could void the user's authority to operate the device.

MODIFICATION : Tout changement ou modification non expressément approuvé par le bénéficiaire de cet appareil peut annuler l'autorisation de l'utilisateur à faire fonctionner l'appareil.

Radio Equipment Directive (RED)

TV Pro 300 includes wireless communication functions (e.g., Bluetooth LE, Wi-Fi and RF) in the Bluetooth remote control, Bluetooth dongle, and Wi-Fi/BT module of the main board. The RF power rating and operating frequencies are as follows:

- Remote control and Bluetooth dongle
 - RF power is <2 dBm
 - RF operating frequency: 2402-2480 MHz
- Intel AX210 on i3 board
 - RF power is <20 dBm
 - RF operating frequency: 2400-2483.5 MHz, 5150-5350 MHz, 5470-5725 MHz, 5745-5825 MHz

Hereby, Teladoc Health declares that the radio equipment type Telehealth Communications System is in compliance with Directive 2014/53/EU. The full text of the EU declaration of conformity is available by clicking here: [Full Declaration of Conformity](#)

IC Warnings

English Version

The device supports 5GHz U-NII 1 frequency band, which is 5.150 to 5.250 GHz. It will be restricted for indoor use only.

Telehealth Communications System complies with IC radiation exposure limits set forth for a controlled environment. This equipment should be installed and operated with minimum distance of 20 cm between the radiator and your body.

This device contains license-exempt transmitter(s)/receiver(s) that comply with Innovation, Science and Economic Development Canada's license-exempt RSS(s). Operation is subject to the following two conditions:

1. This device may not cause interference.
2. This device must accept any interference, including interference that may cause undesired operation of the device.

Version Française

L'appareil prend en charge la bande de fréquence 5GHz U-NII 1, qui est de 5,150 à 5,250 GHz. Il ne sera utilisé qu'à l'intérieur.

Telehealth Communications System est conforme aux limites d'exposition aux rayonnements de la IC établies pour un environnement non contrôlé. Cet équipement doit être installé et fonctionner à au moins 20 cm de distance d'un radiateur ou de votre corps.

L'émetteur/récepteur exempt de licence contenu dans le présent appareil est conforme aux CNR d'Innovation, Sciences et Développement économique Canada applicables aux appareils radio exempts de licence. L'exploitation est autorisée aux deux conditions suivantes :

1. L'appareil ne doit pas produire de brouillage.
2. L'appareil doit accepter tout brouillage radioélectrique subi, même si le brouillage est susceptible d'en compromettre le fonctionnement.

Electromagnetic Compatibility

Guidance and Manufacturer's Declaration

The TV Pro 300 system complies with IEC 60601-1-2 4th edition, General Requirements for Safety – Collateral standard: Electromagnetic compatibility. Performance of the device is unaffected by exposure to the compliance levels described in Tables 1, 2, 3 and 4 in the following section.

Special precautions and installation information for the TV Pro 300 for electromagnetic compatibility (EMC) are provided below:

- Equipment in hospital environments, including the TV Pro 300 and other portable or mobile communications equipment, can produce Electromagnetic Interference (EMI), that may affect the function of these devices. Such effects are prevented by use of equipment with EMI characteristics proven below recognized limits, as identified in the tables below.
- In the event of suspected interference from other equipment, which prevents the proper functioning of the TV Pro 300, contact Teladoc Health and discontinue use of the system until the problem can be remedied.

The following tables contain the Manufacturer's declaration and additional information required by IEC 60601-1-2.

IEC 60601-1-2:2014/AMD1:2020 ME EQUIPMENT and ME SYSTEMS identification, marking and documents for Class A product

The ME EQUIPMENT or ME SYSTEM is suitable for professional healthcare facility.

WARNINGS:

- Don't install near active HF surgical equipment and the RF shielded room of an ME system for magnetic resonance imaging, where the intensity of EM disturbances is high.
- Ne pas installer à proximité d'équipements chirurgicaux HF actifs et de la salle blindée RF d'un système ME pour l'imagerie par résonance magnétique, où l'intensité des perturbations EM est élevée.
- Use of this equipment adjacent to or stacked with other equipment should be avoided because it could result in improper operation. If such use is necessary, this equipment and the other equipment should be observed to verify that they are operating normally.
- L'utilisation de cet équipement à côté ou empilé avec d'autres équipements doit être évitée car cela pourrait entraîner un fonctionnement incorrect. Si une telle utilisation est nécessaire, cet équipement et les autres équipements doivent être observés pour vérifier qu'ils fonctionnent normalement.
- Use of accessories, transducers and cables other than those specified or provided by the manufacturer of this equipment could result in increased electromagnetic emissions or

decreased electromagnetic immunity of this equipment and result in improper operation.

- L'utilisation d'accessoires, de transducteurs et de câbles autres que ceux spécifiés ou fournis par le fabricant de cet équipement peut entraîner une augmentation des émissions électromagnétiques ou une diminution de l'immunité électromagnétique de cet équipement et entraîner un fonctionnement incorrect.
- Portable RF communications equipment (including peripherals such as antenna cables and external antennas) should be used no closer than 30 cm (12 inches) to any part of the audio/video communication system (TV Pro 300), including cables specified by the manufacturer. Otherwise, degradation of the performance of this equipment could result.
- Les équipements de communication RF portables (y compris les périphériques tels que les câbles d'antenne et les antennes externes) ne doivent pas être utilisés à moins de 30 cm (12 pouces) de toute partie du système de communication audio/vidéo (TV Pro 300), y compris les câbles spécifiés par le fabricant. Dans le cas contraire, une dégradation des performances de cet équipement pourrait en résulter.
- To avoid the risk of electric shock, this equipment must only be connected to a supply mains with protective earth.
- Pour éviter tout risque d'électrocution, cet équipement ne doit être connecté qu'à une alimentation secteur avec mise à la terre de protection.

NOTE: Teladoc recommends the use of the HDMI and power cables included with the product. The user is responsible for additional cables and connections made to TV Pro 300.

Table 1: Electromagnetic Emissions

1. All necessary instructions for maintaining BASIC SAFETY and ESSENTIAL PERFORMANCE with regard to electromagnetic disturbances for the excepted service life.
2. Guidance and manufacturer's declaration -electromagnetic emissions and Immunity.

The TV Pro 300 is intended for use in the electromagnetic environment specified below. The customer or the user of the TV Pro 300 should assure that it is used in such an environment.

Emissions Test	Compliance
RF Emissions CISPR 11	Group 1
RF Emissions CISPR 11	Class A
Harmonic Emissions IEC 61000-3-2	Class A
Voltage Fluctuations / Flicker Emissions IEC 61000-3-3	Complies

Table 2: Electromagnetic Immunity

The TV Pro 300 system is intended for use in the electromagnetic environment specified below. The customer or the user of the TV Pro 300 should assure that it is used in such an environment.

CAUTION: An Electro Static Discharge (ESD) event may cause the system to lose functionality for a short amount of time. If the event does not recover automatically, power cycle the device.

Immunity Test	IEC 60601-1-2 Test Level	Compliance Level	Electromagnetic Environment - Guidance
Electrostatic Discharge (ESD) IEC 61000-4-2	±8 kV contact ±2 kV, ±4 kV, ±8 kV, ±15 kV air	±8 kV contact ±2 kV, ±4 kV, ±8 kV, ±15 kV air	Floors should be wood, concrete or ceramic tile. If floors are covered with synthetic material, the relative humidity should be at least 30%.
Electrical Fast Transient / Burst IEC 61000-4-4	Power supply lines: ±2 kV 100 kHz repetition frequency	Power supply lines: ±2 kV 100 kHz repetition frequency	Mains power quality should be that of a typical commercial or hospital environment.
Surge IEC 61000-4-5	line(s) to line(s): ±1 kV.	line(s) to line(s): ±1 kV.	Mains power quality should be that of a typical commercial or hospital environment.
Voltage Dips, Short Interruptions, and Voltage Variations on Power Supply Input Lines IEC 61000-4-11	0% 0.5 cycle At 0°, 45°, 90°, 135°, 180°, 225°, 270° and 315° 0% 1 cycle And 70% 25/30 cycles Single phase: at 0 0% 300 cycle	0% 0.5 cycle At 0°, 45°, 90°, 135°, 180°, 225°, 270° and 315° 0% 1 cycle And 70% 25/30 cycles Single phase: at 0 0% 300 cycle	Mains power quality should be that of a typical commercial or hospital environment. If the user of the device requires continued operation during power mains interruptions, it is recommended that the Lite 4 with Boom Camera be powered from an uninterruptible power supply (UPS) or a battery.
Power frequency Magnetic Field IEC 61000-4-8	30 A/m 50Hz/60Hz	30 A/m 50Hz/60Hz	Power frequency magnetic fields should be at levels characteristic of a typical location in a typical commercial or hospital environment.

Immunity Test	IEC 60601-1-2 Test Level	Compliance Level	Electromagnetic Environment - Guidance
Conducted RF IEC61000-4-6	150KHz to 80MHz: 3Vrms 6Vrms (ISM bands between) 80% Am at 1kHz	150KHz to 80MHz: 3Vrms 6Vrms (ISM bands between) 80% Am at 1kHz	<p>Portable and mobile RF communications equipment should be used no closer to any part of the TV Pro 300, including cables, than the recommended separation distance calculated from the equation applicable to the frequency of the transmitter. Recommended separation distance:</p> $d = 1.2 \sqrt{P}$ $d = 1.2 \sqrt{P} \quad 80 \text{ MHz to } 800 \text{ MHz}$ $d = 2.3 \sqrt{P} \quad 800 \text{ MHz to } 2.5 \text{ GHz}$
Radiated RF IEC61000-4-3	3 V/m 80 MHz - 2,7 GHz 80 % AM at 1 kHz	3 V/m 80 MHz - 2,7 GHz 80 % AM at 1 kHz	<p>where P is the maximum output power rating of the transmitter in watts (W) according to the transmitter manufacturer and d is the recommended separation distance in meters (m). Field strengths from fixed RF transmitters, as determined by an electromagnetic site survey^a, should be less than the compliance level in each frequency range^b.</p>
Proximity magnetic fields IEC 61000-4-39	30 kHz: 8A/m 134.2 kHz: 65A/m 13.56 MHz: 7.5A/m	Not application Or 30 kHz: 8A/m 134.2 kHz: 65A/m 13.56 MHz: 7.5A/m	<p>Interference may occur in the vicinity of equipment marked with the following symbol:</p> 

U_T is the a.c. mains voltage prior to application of the test level.

Table 3: Electromagnetic Immunity - Enclosure Port Immunity

TV Pro 300 is intended for use in the electromagnetic environment specified below. The customer or the user of an TV Pro 300 should assure that it is used in such an environment.

Guidance and manufacturer's declaration - electromagnetic Immunity								
Radiated RF IEC61000-4-3 (Test specifications for ENCLOSURE PORT IMMUNITY to RF wireless communications equipment)	Test Frequency (MHz)	Band (MHz)	Service	Modulation	Maximum Power(W)	Distance (m)	IEC 60601-1-2 Test level (V/m)	Compliance level (V/m)
	385	380 - 390	TETRA 400	Pulse modulation 18 Hz	1,8	0.3	27	27
	450	430- 470	GMRS 460, FRS 460	FM \pm 5 kHz deviation 1 kHz sine	2	0.3	28	28
	710	704 - 787	LTE Band 13, 17	Pulse modulation 217 Hz	0,2	0.3	9	9
	745							
	780							
	810	800 - 960	GSM 800/900, TETRA 800, iDEN 820, CDMA 850, LTE Band 5	Pulse modulation 18 Hz	2	0.3	28	28
	870							
	930							
	1720	1 700 - 1 990	GSM 1800; CDMA 1900; GSM 1900; DECT; LTE Band 1, 3, 4, 25; UMTS	Pulse modulation 217 Hz	2	0.3	28	28
	1845							
	1970							
	2450	2 400 - 2 570	Bluetooth, WLAN, 802.11 b/g/n, RFID 2450, LTE Band 7	Pulse modulation 217 Hz	2	0.3	28	28
	5240	5 100 - 5 800	WLAN 802.11 a/n	Pulse modulation 217 Hz	0,2	0.3	9	9
	5500							
5785								

Table 4: Recommended separation distances

Recommended separation distances between portable and mobile RF communications equipment and the TV Pro 300.

The TV Pro 300 is intended for use in an electromagnetic environment in which radiated RF disturbances are controlled. The customer or the user of the TV Pro 300 can help prevent electromagnetic interference by maintaining a minimum distance between portable and mobile RF communications equipment (transmitters) and the TV Pro 300 as recommended below, according to the maximum output power of the communications equipment.

Guidance and manufacturer's declaration - electromagnetic Immunity		
Test frequency	Modulation	Immunity Test Level (A/m)
30 kHz	CW	8
134,2 kHz	Pulse modulation ^a 2,1 kHz	65 ^b
13,56 MHz	Pulse modulation ^a 50 kHz	7,5 ^b

a) The carrier shall be modulated using a 50% duty cycle square wave signal.
b) r.m.s., before modulation is applied.

For transmitters rated at a maximum output power not listed above, the recommended separation distance d in meters (m) can be estimated using the equation applicable to the frequency of the transmitter, where P is the maximum output power rating of the transmitter in watts (W) according to the transmitter manufacturer.

NOTES

1. At 80 MHz and 800 MHz, the separation distance for the higher frequency range applies.
2. These guidelines may not apply in all situations. Electromagnetic propagation is affected by absorption and reflection from structures, objects and people.

Virtual Care System

Health systems view virtual care as an extension of their services, relying on a combination of software, hardware, networks, systems and people to work together to deliver improved access and care to their patients.

Enabling healthcare's only integrated virtual care platform, Teladoc Health powers virtual encounters at clinics, healthcare facilities and patient homes for an integrated experience across a multitude of use cases. Built on our cloud-based network, Solo™ is the backbone to delivering care anywhere at any time. It provides users with everything they need to streamline their telehealth needs for fast user adoption.

Designed for healthcare, security and reliability

Our cloud-based, patented network ensures the industry's highest standards for protecting and securing sensitive healthcare information. Our downloadable and web-based platform allows users to access virtual care across a broad range of consumer and telehealth devices in a variety of clinical environments.

Definition of “Device”

Use of the word “device(s)” in this User Guide refers to Teladoc Health telehealth products, not medical devices as defined in Section 201(h) of the Federal Food, Drug, and Cosmetic Act (FD&C) Act.

In addition, the term “mobile devices” refers to smartphones and tablets.

Before You Begin

The TV Pro 300 should be installed by an IT professional to ensure proper setup and network configuration.

Before setting up your TV Pro 300, review the Teladoc Health Telehealth Network Specifications document (MB-14011) to configure your network to optimize the telehealth consultation experience. If you do not have the Teladoc Health Telehealth Network Specifications document, please contact your local Teladoc Health Product Specialist.

It is not recommended that the TV Pro 300 be shutdown, but if shut down is required, follow the procedure ["TV Pro 300 Power Off Sequence" on page 22](#).

Intended Use

The Teladoc Health TV Pro 300 is intended to provide high-quality, HIPAA-compliant audio and video sessions between a provider and a patient over the Teladoc Health Telehealth Network.

- Trained healthcare professionals are the intended users of the Teladoc Health TV Pro 300. Users of the system require clinical judgment and experience to review and interpret the patient data transmitted.
- Teladoc Health TV Pro 300 is intended to be used in the Professional Healthcare Facility environment.

General Ecosystem Requirements

- Television display with HDMI inputs or computer display
- Access to a clinical Wi-Fi network or LAN
- USB keyboard and mouse for easy installation

TV Pro 300 Overview

TV Pro 300 is an integrated telehealth product that allows for a two-way virtual consult through the television. Because TV Pro 300 is equipped with two night vision cameras, remote physicians can clearly examine the patient at any time of the day.

TV Pro 300 What's in the Box



- TV Pro 300 device
- Wall mounting assembly
 - Mounting plate (rectangular piece)
 - Mounting bracket
 - 2 anchors (2 short slots)
 - 2 Allen keys (1 long slot)
 - Screws

- Remote control
 - Remote control
 - Holster
 - 2x AAA batteries
 - 2 screws for mounting the holster
- Cables
 - HDMI cable
 - Power cable
- Quick reference guide QR code to the full User Guide

TV Pro 300

Front View



Rear View

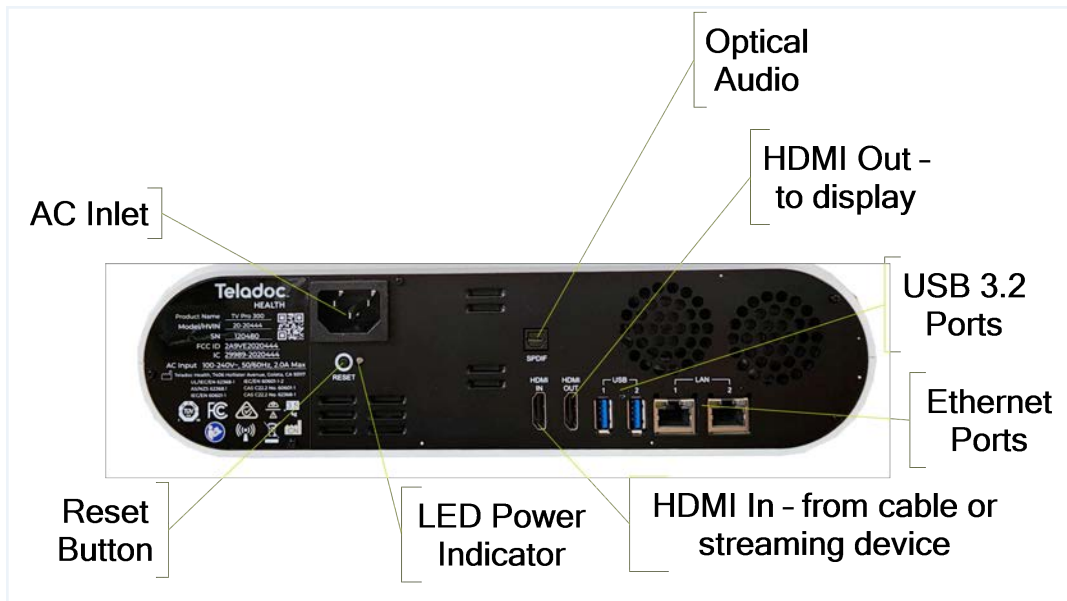

TV Pro 300 Remote Control

		OK	Select the button
		Arrows	Navigate between the buttons
		Back	Go back to previous page
		Home	Go to Teladoc Health Application
		TV	Go to Entertainment
		Vol +/-	Controls TV Pro 300 speaker volume
		Voice	Engages the microphone on the top of the remote control to listen to voice command.
LED	Lights up when: <ul style="list-style-type: none"> • in pairing mode • microphone is listening for voice command • battery is low 		

NOTES:

- The remote control has braille near selected buttons for accessibility.
- The remote control comes already paired with the TV Pro 300.
- The microphone is located on the top curved surface of the remote control.

CAUTION: Replace remote control batteries when the remote's LED flashes alternating blue and orange 10 times when a key is pressed.

Remote Control Locator

See ["TV Pro 300 Settings Menu" on page 28](#)

TV Pro 300 Wi-Fi Connection Setup

NOTES:

- Advanced Wi-Fi set up should be done only by a trained technician.

1. Press "Ctrl - Shift - Space" on the keyboard to bring up Debug mode.
2. Click the "X" at the top-right of the window to close the Robot software.

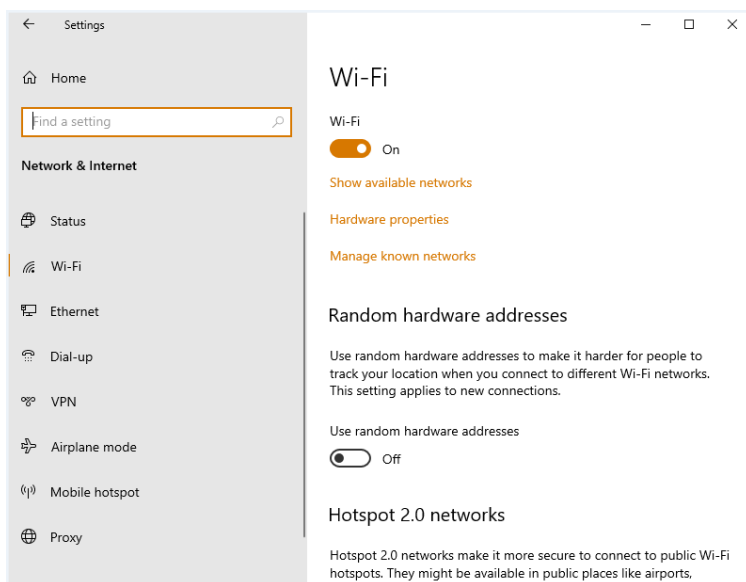
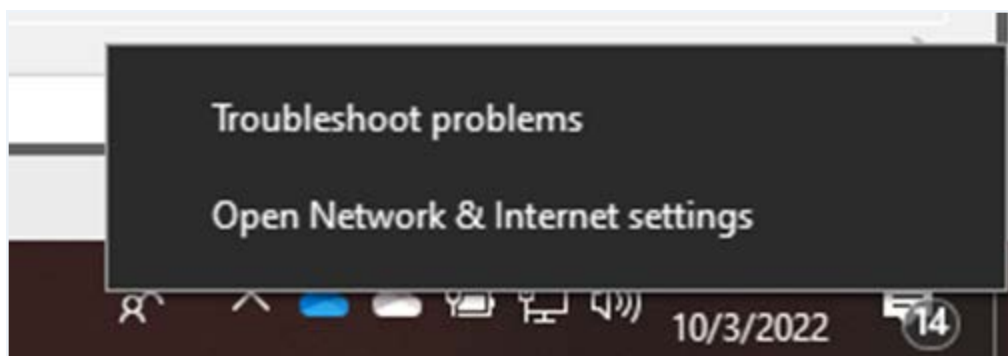

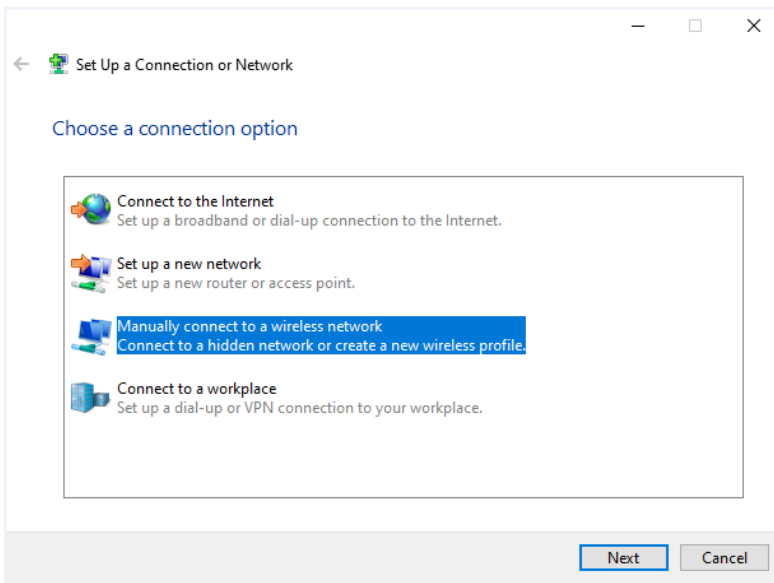
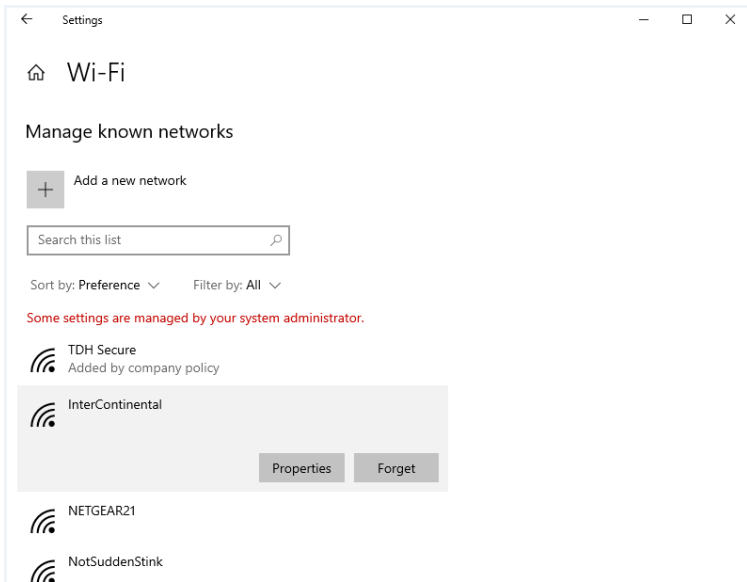

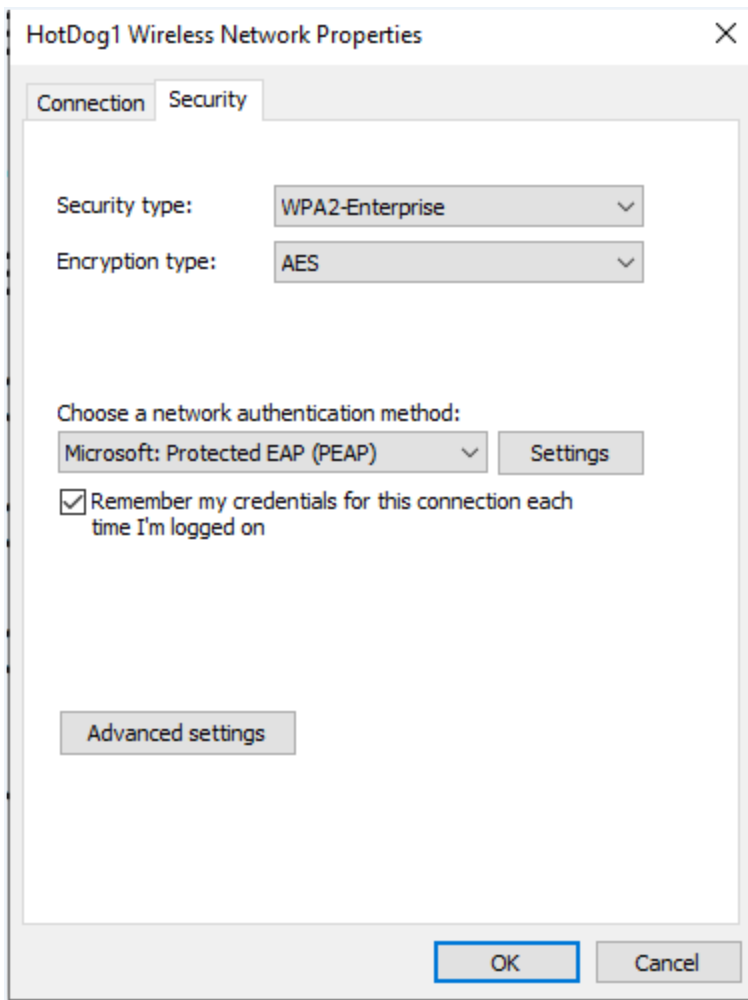

TV Pro 300 Power On Sequence

1. Connect the TV Pro 300 to a power outlet.
2. Connect the TV Pro 300 to a display using the HDMI cable.
 - The TV Pro 300 will automatically power on.
3. Log in to the runtime account.
 - The Teladoc Health application will start automatically as shown by the screensaver.

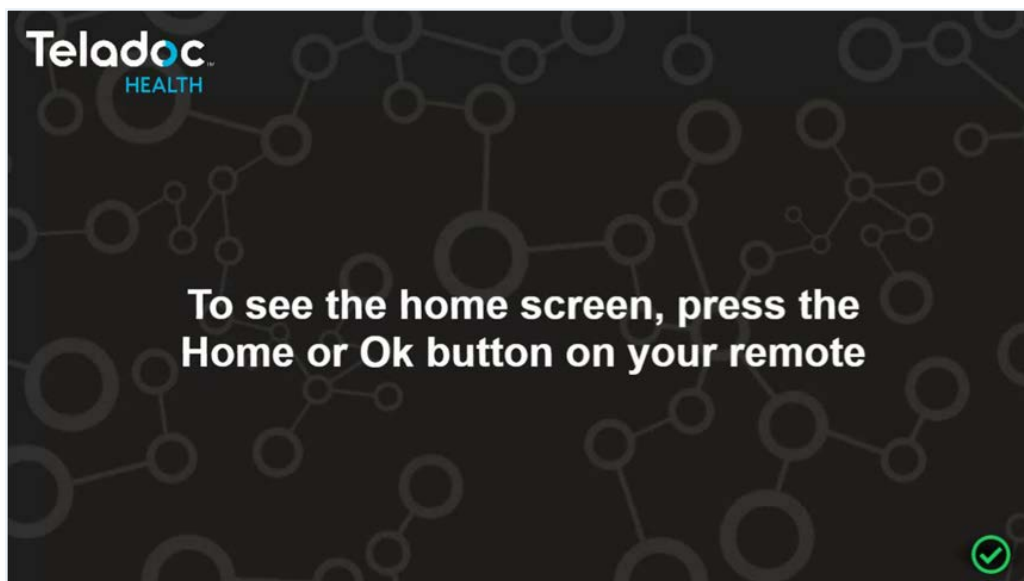

TV Pro 300 Power Off Sequence

Graceful Shutdown

1. Press and release the Reset button on the back to gracefully shut down the device.
2. AC power can be disconnected from the device after shutdown.

Hard Shutdown

1. Press and hold the Reset button on the back for a hard shutdown.
2. AC power can be disconnected from the device after shutdown.

TV Pro 300 Wall Mounting Instructions

NOTES:

- Mount near the television.
- Mount away from noisy areas such as air vents and ventilators.

Tools Needed:

- Phillips head screwdriver
- Electric drill

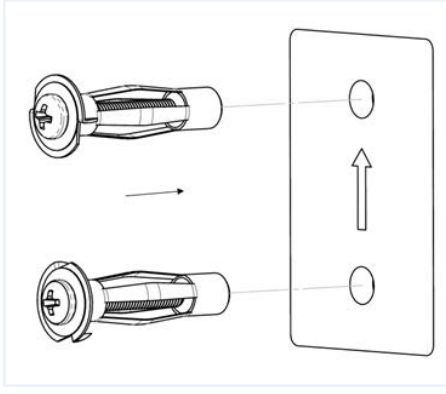
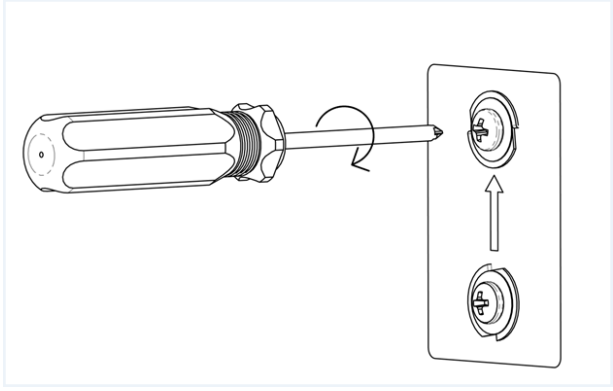
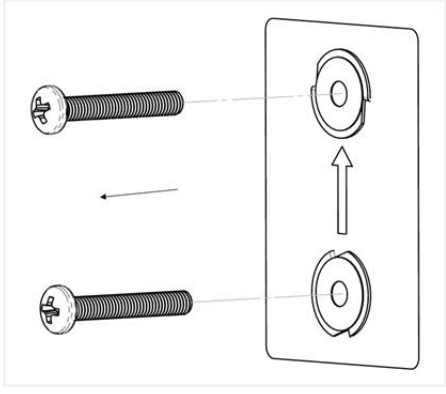

Step	Action	Image
1.	Place adhesive-backed template in desired mounting location and, utilizing the provided drill bit, drill 2 openings in the locations marked in the template.	
2.	Insert the provided wall anchors in the openings drilled on the template.	
3.	Once anchors are installed, use a Philips head screwdriver to expand the locking features on other side of drywall (not visible).	
4.	Remove screws from anchors.	

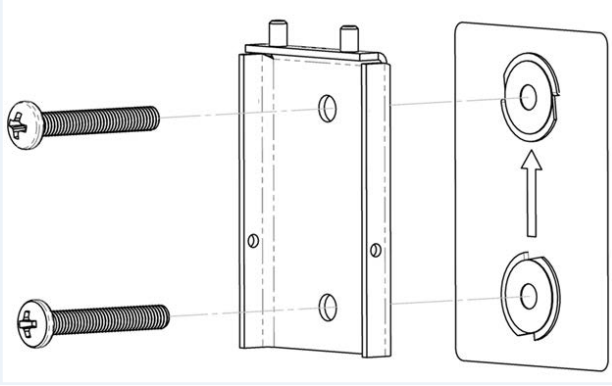
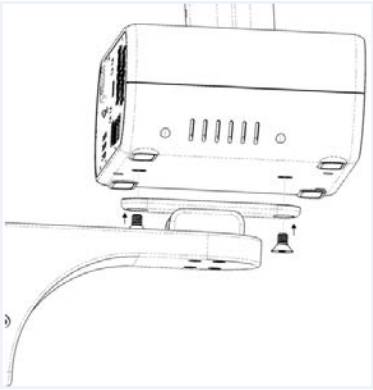
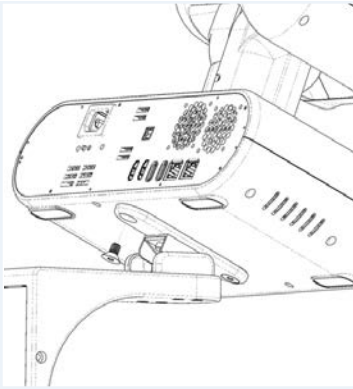
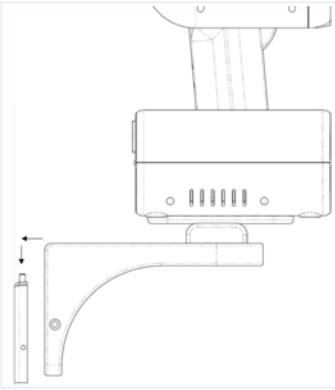
Step	Action	Image
5.	Mount bracket to wall. Ensure locating pins face upward and flat side of bracket faces the wall like shown in the image.	
6.	Mount device to wall mount bracket using 1/4-20 flat head screws.	
	Use pan/tilt capabilities of wall mount to ease installation of screws.	
7.	Slide bracket/device assembly over sheet metal bracket and against wall, engaging locating pins in wall mount bracket.	

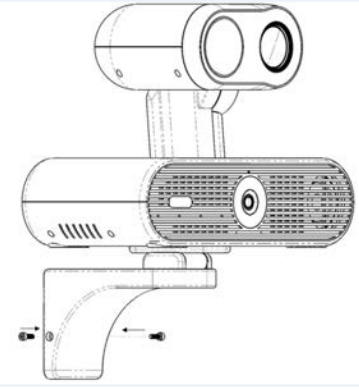
Step	Action	Image
8.	Secure bracket using two M4 screws provided.	 A technical line drawing of a medical device assembly. It shows a cylindrical component with a lens-like front and a bracket-like structure below it. Two screws are shown being inserted into the bracket to secure it to a base. The drawing is a perspective view.

TV Pro 300 Hardware Setup After Mounting

1. Ensure batteries are installed inside the TV Pro 300 remote control.
2. Connect the TV Pro 300 to a power outlet.
3. Connect the TV Pro 300 to the desired television HDMI port.
4. Connect the TV Pro 300 to the wall Ethernet port or use Wi-Fi.
 - The TV Pro 300 will automatically power on and log in to the runtime account.
 - The Teladoc Health application will start automatically as shown by the screensaver.

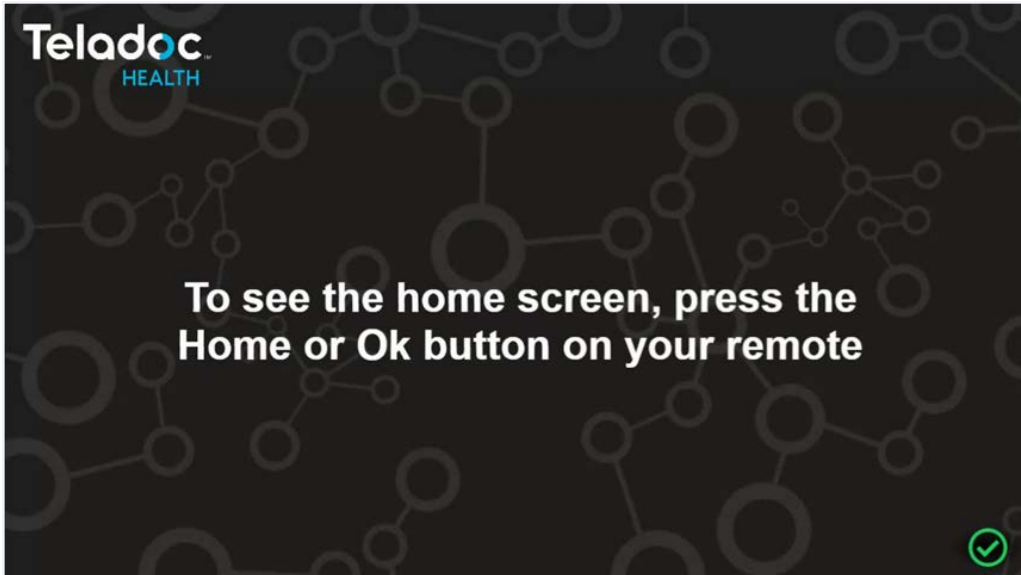

5. Press **OK** on the remote control to see **About this device**.

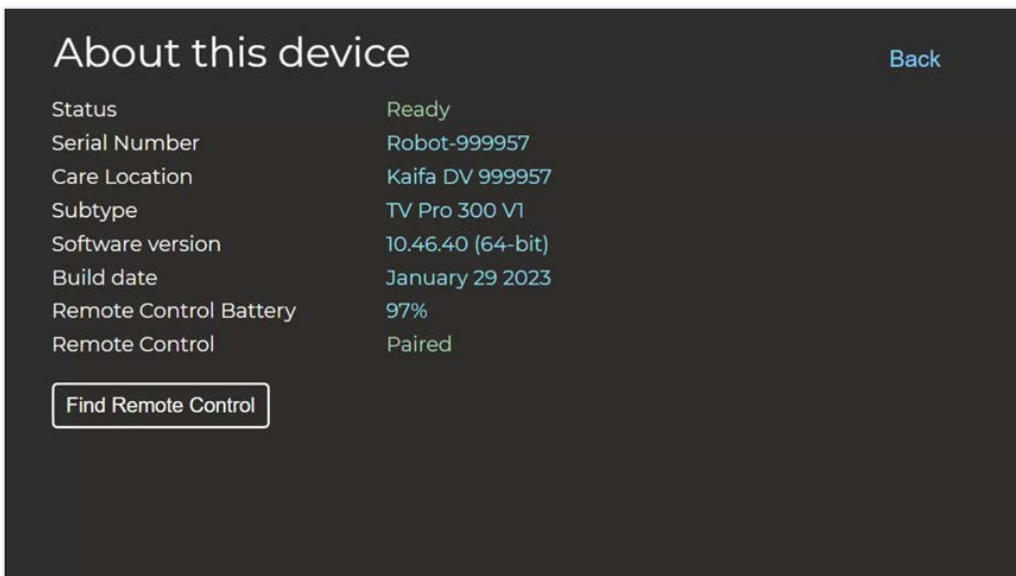

TV Pro 300 Settings Menu

On the remote control, **simultaneously** press **↑↓** to show the Settings menu. The user can use **↑↓** to navigate and **OK** to select from the four options.



About this device

Shows the status and various support information about the device.

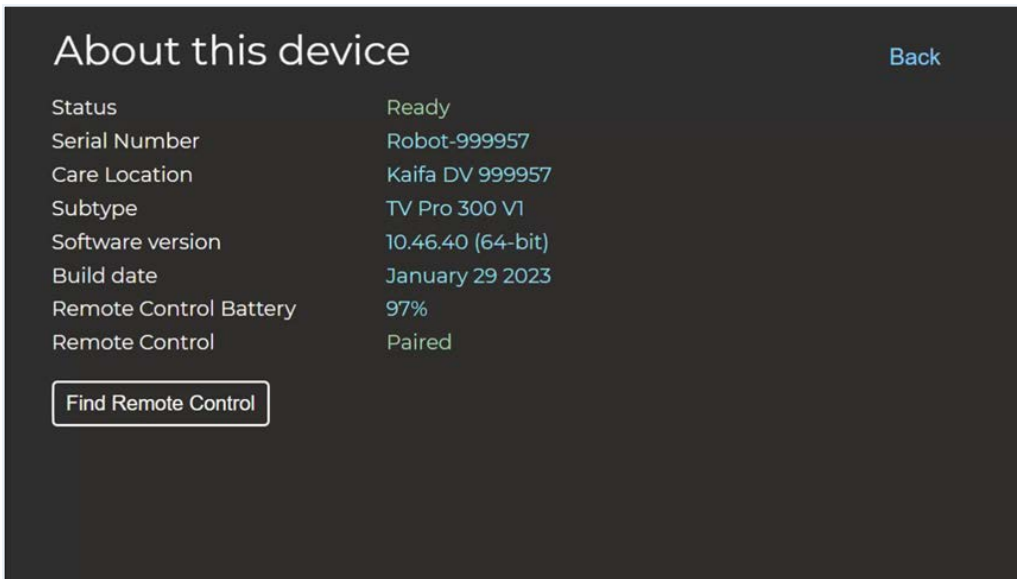

Find Remote Control

NOTE: If the remote control is lost, a USB keyboard or mouse needs to be connected to the TV Pro 300 to access the **Find Remote Control** feature.

To locate the remote control using a sound, from the **About this device** screen:

Navigate to:

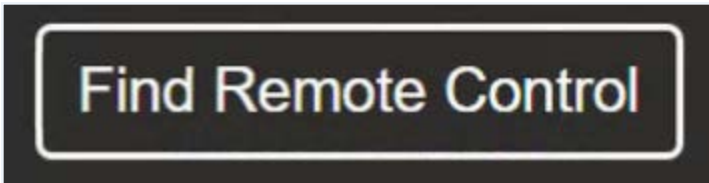

A sound will play on the remote control and the button will change to:

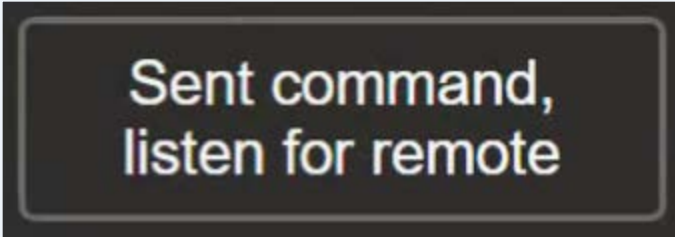

Network

Shows the hospital internet connectivity and allows the user to run a checkup on the Teladoc Health network status.

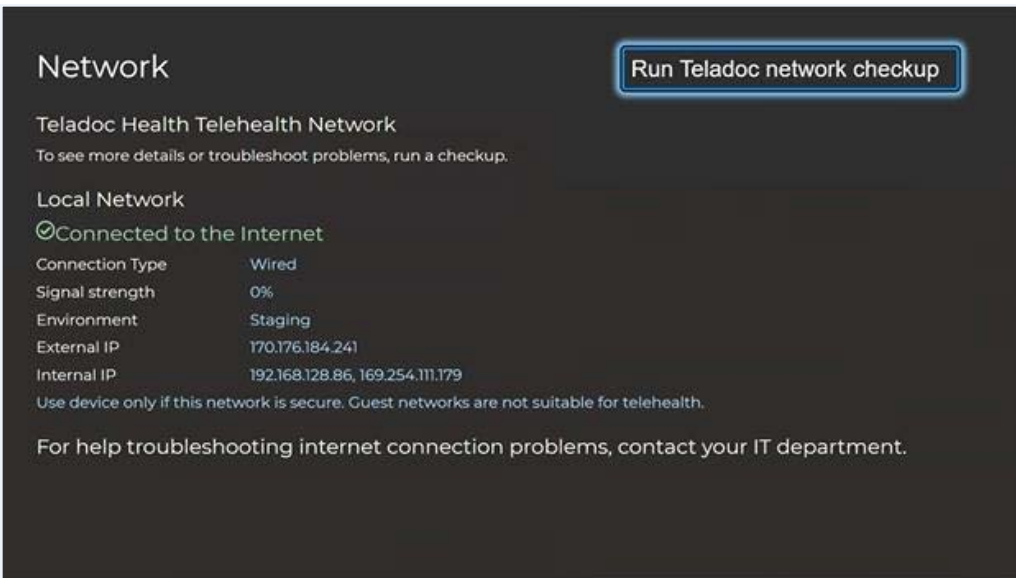

Stethoscope

Allows the user to connect and select a Bluetooth stethoscope if needed.

NOTE: The TV Pro 300 does not require a stethoscope for use.

Stethoscope type

Back

None

Eko / Littmann CORE

To connect a new stethoscope, make sure it is on and hold it near the Teladoc device. The stethoscope should appear below, and you can select it to connect.

Eko Core (88:D2:11:CE:EE:61) Ready to connect

Default camera position

Allows the user to preset the direction the camera is facing in and out of a virtual session.

After selecting **Default camera position**, the user will first see **Fixed** camera view. With the TV Pro 300 wall mounted, previewing the **Fixed** camera view (denoted as **Wide Angle**) will allow the user to adjust the tilt of the mount if needed.



Using the **←** and **→** arrows, the user can select the **Main** camera or the **Wide Angle** camera.



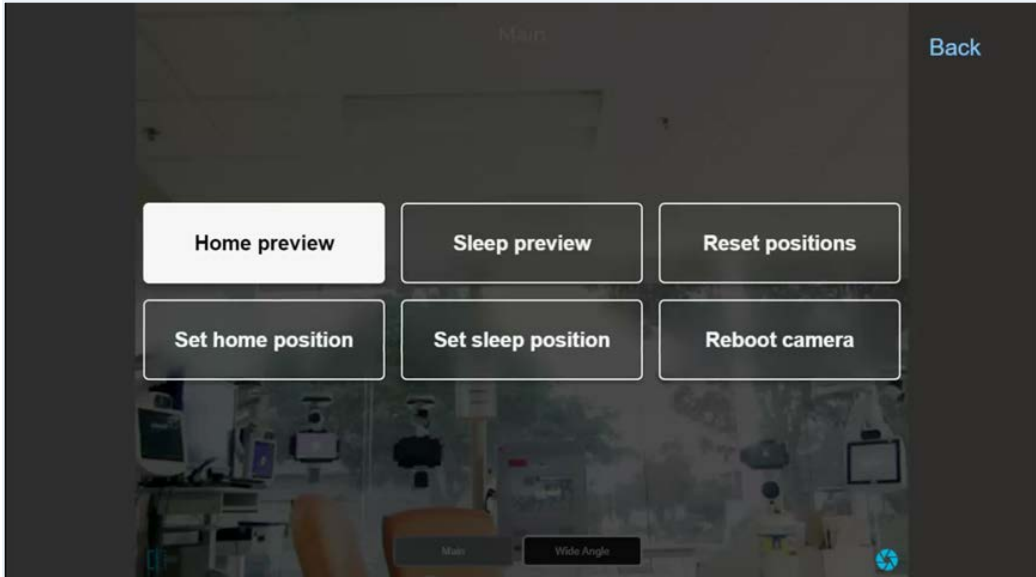

TV Pro 300 PTZ Camera Settings

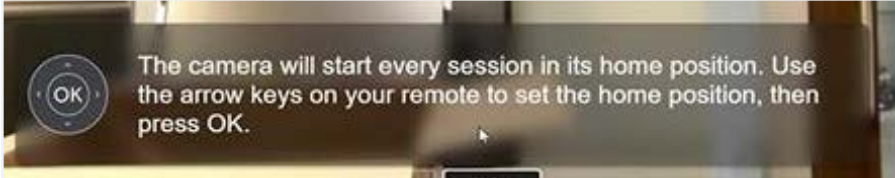
The user can select the shutter icon  on the bottom right corner to reveal the six buttons relating to the PTZ camera.



Button	Function
Home preview	Allows the user to preview the home position, which is the camera position during a virtual session.
Set home position	<p>Allows the user to set the home camera position. When this button is pressed, a message will inform the user how to set that with the remote control.</p> <div data-bbox="467 1094 1357 1451" style="border: 1px solid black; padding: 5px; margin: 10px 0;">   </div>
Sleep preview	Allows the user to preview the sleep position, which is the camera position when there is no virtual session.

<p>Set sleep position</p>	<p>Allows the user to set the sleep camera position. When this button is pressed, a message will inform the user how to set that with the remote control.</p> <div data-bbox="467 184 1356 331" style="border: 1px solid black; padding: 5px; margin: 10px 0;">  </div> <div data-bbox="467 363 1356 510" style="border: 1px solid black; padding: 5px; margin: 10px 0;">  </div>
<p>Reset positions</p>	<p>Reset the PTZ camera.</p>
<p>Reboot camera</p>	<p>Reboot PTZ camera - cycles the PTZ camera's power.</p>

Privacy Mode

With privacy mode enabled, physicians and care teams can request a visit with audio only and have the option to establish a video connection with the patient after receiving verbal approval to connect.

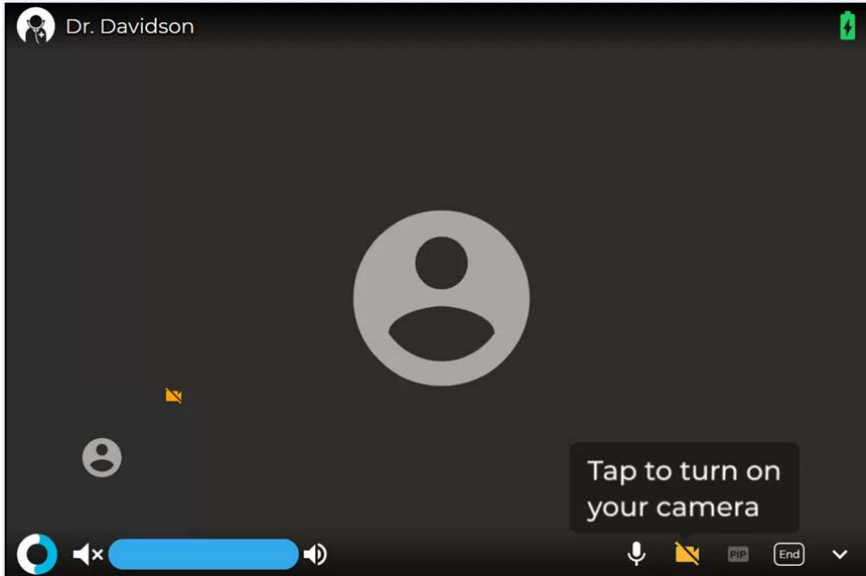

The inpatient care experience ensures patient privacy by allowing the patient to verbally accept or decline a virtual visit request.



Privacy Mode Toggle

The **Privacy Mode** can be toggled on or off in the device's **More Options** screen from the **Settings** screen.

To toggle the **Privacy Mode** on or off:

1. Select the **Settings** icon  to open the Settings screen.
2. Select the **More Options** icon .
3. Toggle the **Start Sessions in Privacy Mode** on or off.

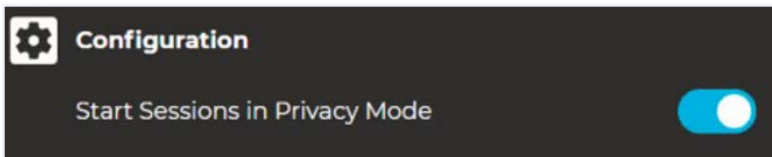

4. Select  to exit the **More Options** screen.

Request a Virtual Nurse

Television Status

Television Is Off

Go to the Virtual Nurse home screen, from the remote control:

1. Press OK.
2. Press the Home button.

Entertainment Media Is On

Press the Home button on the remote control to open the Virtual Nurse home screen.

Request a Virtual Nurse

1. Press the OK button on the remote control.
 - This will open the Request video call screen.

NOTE: If there is no input from the remote control after 10 minutes, the Virtual Nurse experience returns to the Idle screen.

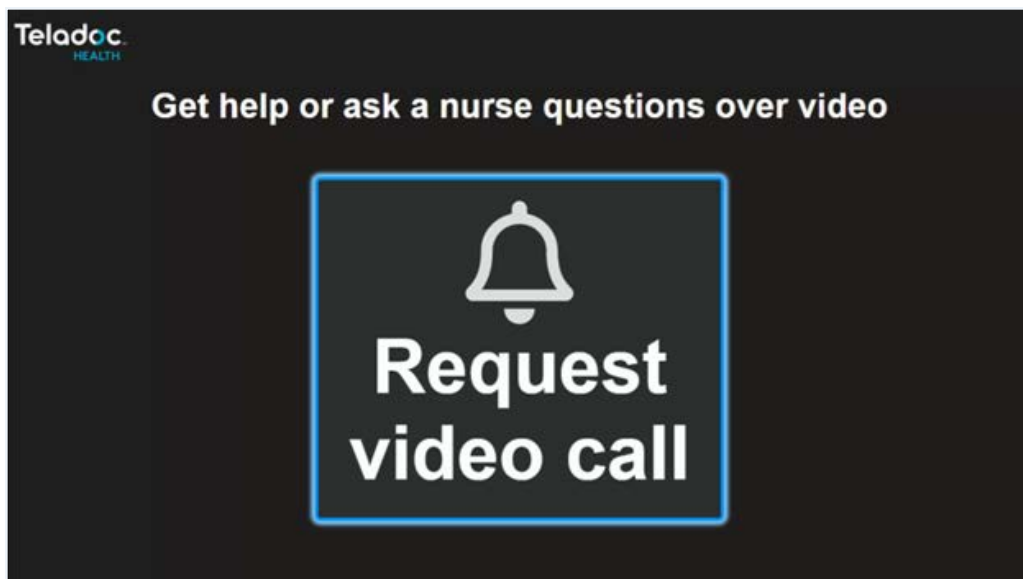

2. Press the OK button on the remote control.
 - This opens the Requesting Nurse call screen



Requesting Nurse call

Request sent

From the Request Sent screen, the options to **Cancel request** and **Watch TV** are available by using the remote control.



Request sent

A nurse will call you as soon as possible.
Feel free to watch TV while you wait.

Cancel request

Watch TV

Watch TV

Select Watch TV using the navigation buttons on the remote control, then press OK.

- The Switching to TV screen will display.

NOTE: While watching TV, press the Home button on the remote control to return to the Request Sent screen.

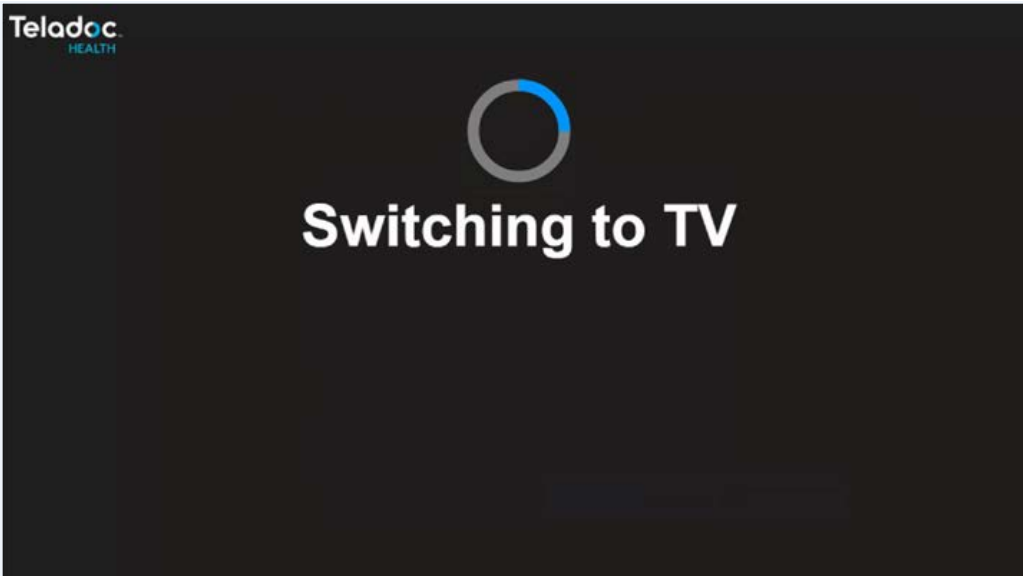

Cancel Virtual Nurse Request

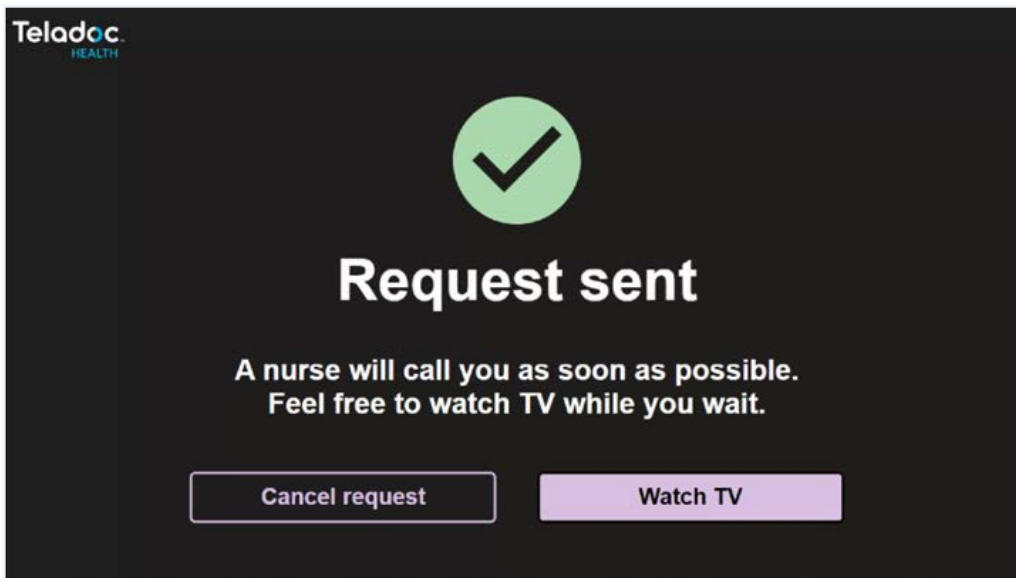

From the Request Sent screen:

1. Use the navigation keys on the remote control to select **Cancel request**.
2. Press OK on the remote control.
3. Use the remote control to confirm request cancellation.

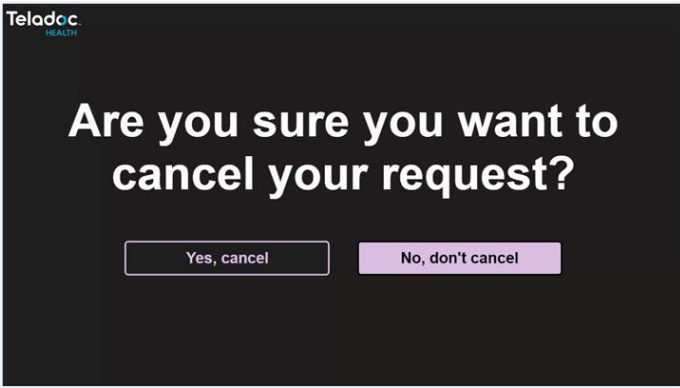

Yes cancel: Returns to Request video call screen.

No, don't cancel: Returns to the Request sent screen.

Virtual Nurse Call

When the Virtual Nurse call is getting ready to begin, the following screen will display.

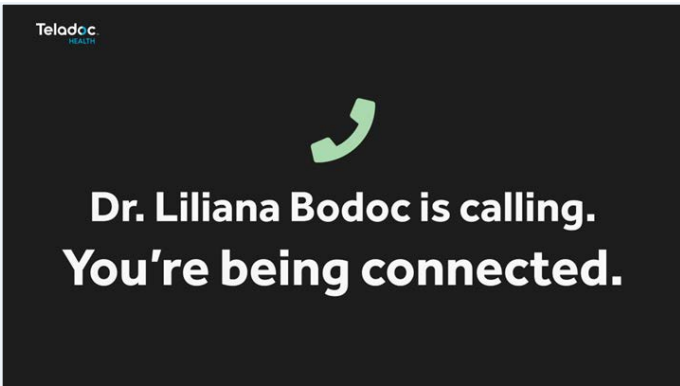

NOTE: The call is automatically placed in Privacy Mode with the patient-side camera turned off.

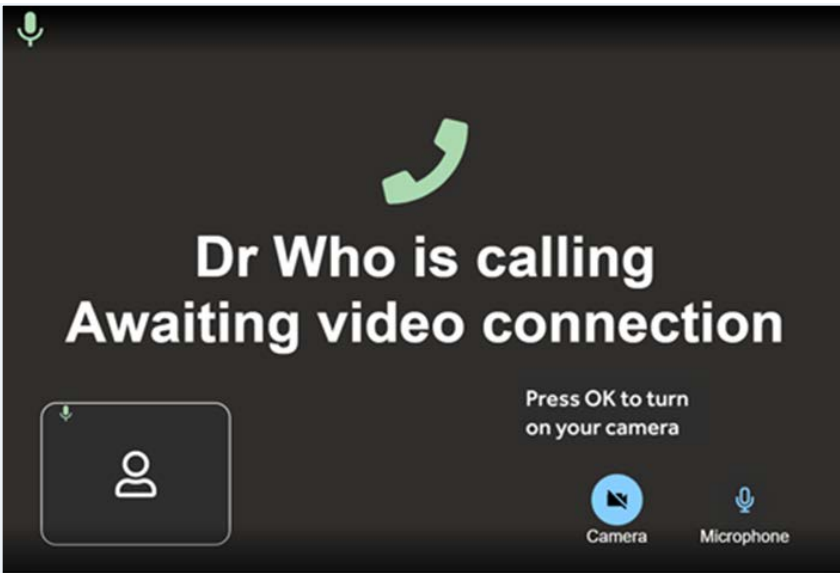

Press OK on the remote control to turn on the patient-side camera or tell the virtual nurse the camera can now be turned on.

NOTE: The camera icon will disappear when the patient-side camera is active.

Active Virtual Nurse Video Call



The following screen displays when the call is ended.

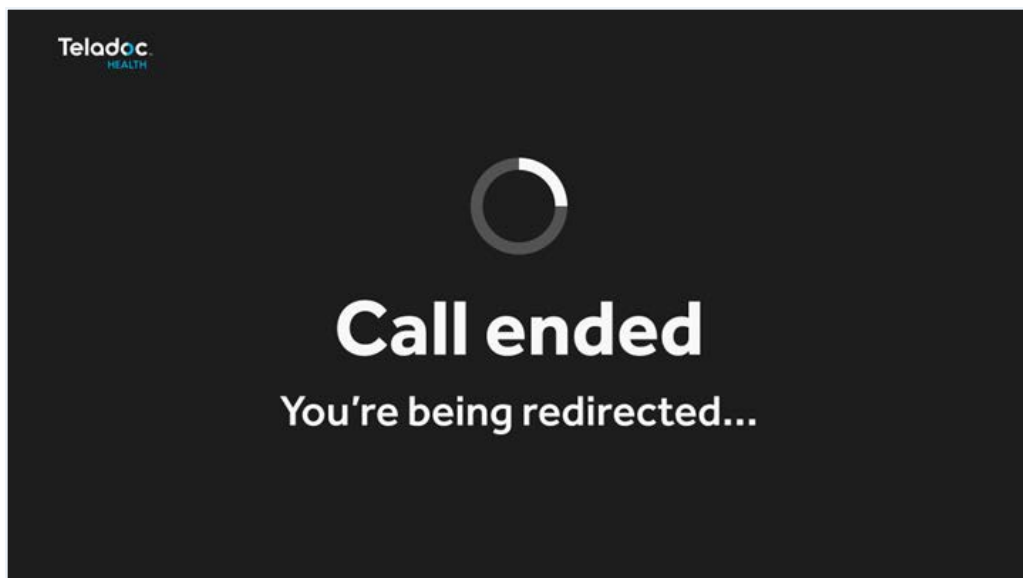





Active Session Screen Navigation

When a Virtual Care session is in progress, a toolbar similar to the one below is displayed.

NOTE: If the device does not have a touchscreen, either a Bluetooth or USB keyboard can be attached to the device and used to select any of the below options.



Icon	Function
	Volume control: Move slider to adjust device's volume. Mute the local volume by dragging the slider to the left or pressing the left-most speaker icon.
	Mutes the device's microphone; tap again to unmute.
	Turns off the video.
	Toggles the Picture-in-Picture.
	Ends the current remote session. A confirmation box will display before the remote session is ended.

Device Audio and Video Mute

The video can be paused by either the remote specialist or on the patient-side device.

Practitioner Mute Icons



Device Mute Icons



TV Pro 300 Specifications

Without Mounting Bracket:
7.7 lb (3.5 kg)
With Mounting Bracket:
9.0 lb (4.1 kg)

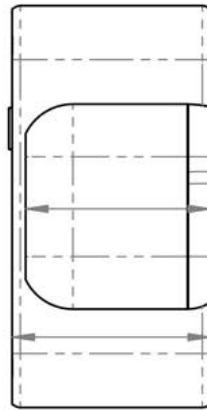

[137mm]
5.39in

[147mm]
5.79in

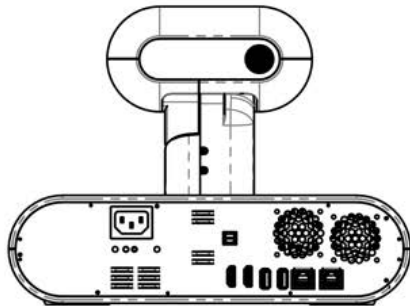

[221mm]
8.70in

[81mm]
3.19in

0

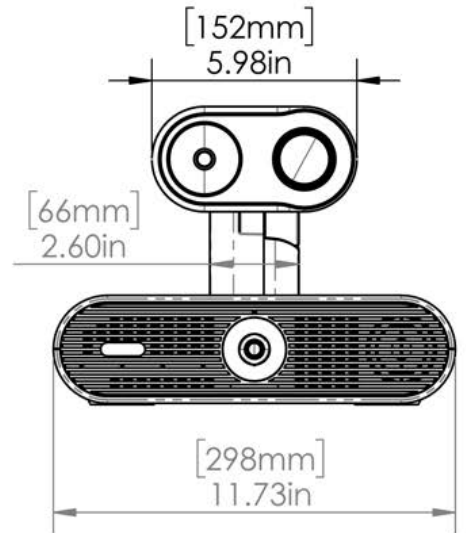
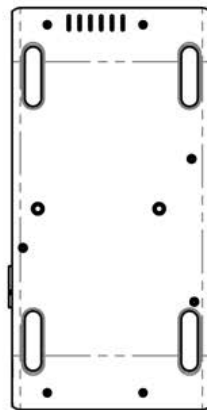

[152mm]
5.98in

[66mm]
2.60in

[298mm]
11.73in

When Wall Mounted

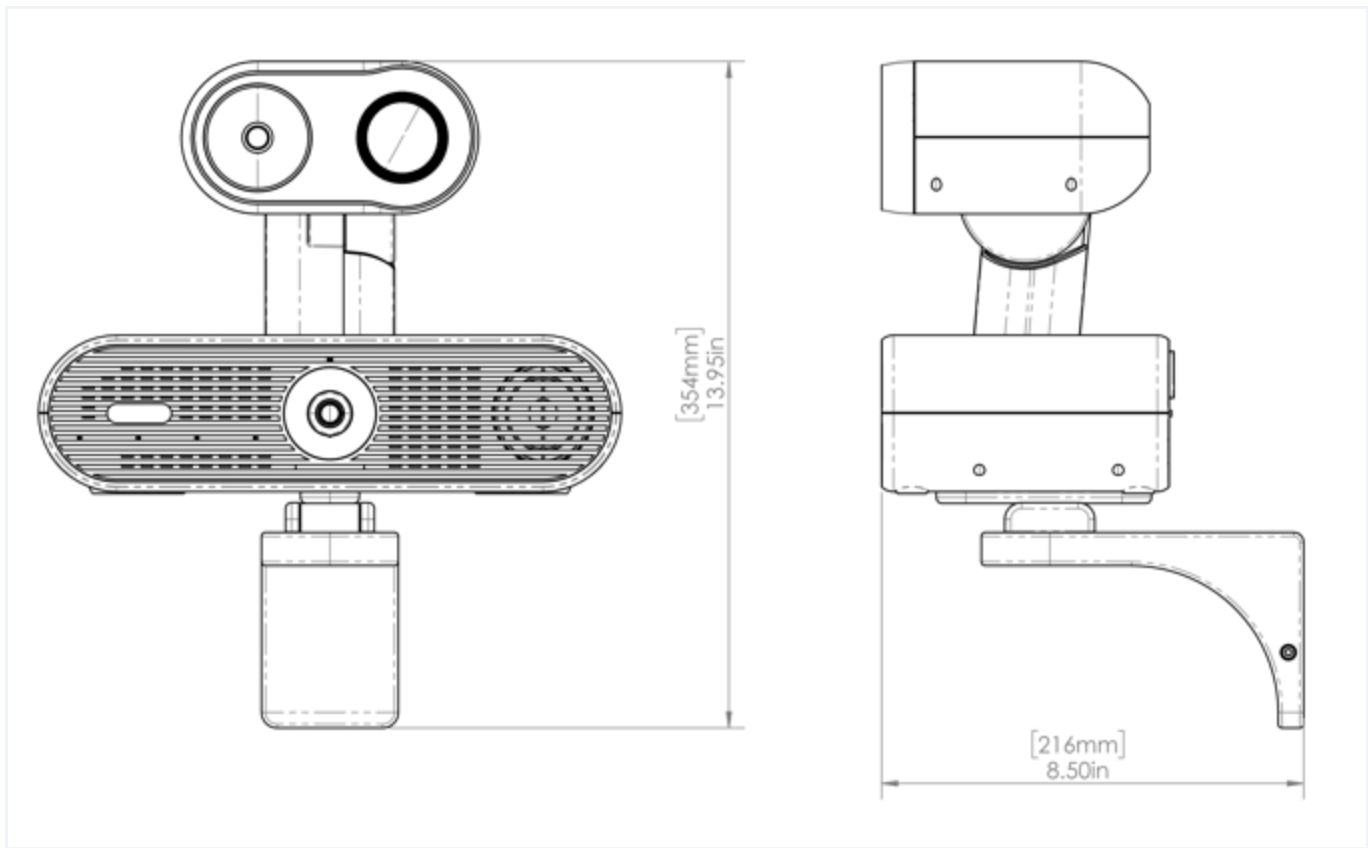

TV Pro 300 Performance Specifications

Audio	Directional Microphone: For focused conversation Linear Array Microphone: For voice control Speaker: 20W full-range speaker
Camera	Fixed Camera: High Definition (HD), 3.5x Digital Zoom, 30 fps, 1080p Pan-Tilt-Zoom Camera: High Definition (HD), 20x Optical + 3.5x Digital Zoom, 30 fps, 1080p
HDMI	HDMI Input: For pass-through HDMI Output: Connect to display with CEC Control
USB Ports	2x USB 3.2 ports intended for hospital IT to service the device for maintenance purposes Each Port Output Power: 4.5W (5V DC x 0.9A)
Wireless Network	Wi-Fi 802.11 ac/a/b/g/n Bluetooth 4.1
Wired Network	2x Gigabit Ethernet
Service Life-cycle	8 years at minimum
SPDIF	SPDIF optical audio port is for technical use by authorized personnel trained by Teladoc Health.

TV Pro 300 Input Power Specifications

Voltage	100-240 VAC
Frequency	50/60 Hz
Current	2.0 A

Environmental Specifications

Operating:

Designed to operate in an indoor environment suitable for human personnel. (10° to 35°C, 30% to 75% RH, 700 hPa to 1,013 hPa) from 0 to 10,000 ft (3,048 m)

Non-operating:

Designed to travel to installations in commercial and cargo airliners and standard ground transportation. (0° to +50°C, 10% to 95% RH, 700 hPa to 1,013 hPa) from 0 to 10,000 ft (3,048 m)

RF Power Rating and Frequencies

Remote Control and Bluetooth Dongle

- RF power is <2 dBm, and the distance between antenna and human is >1 mm separation, thus TV Pro 300 remote control does not need to be tested to SAR standard
- RF operating frequency: 2402-2480 MHz

Intel AX210 on i3 Board

- RF power is <20 dBm.
- RF operating frequency: 2400-2483.5 MHz, 5150-5350 MHz, 5470-5725 MHz, 5745-5825 MHz

TV Pro 300 Electrical and Safety Test Standards

Electrical Equipment Test Standards

Standard Category	Standard field	Certificate	Detail Standards
IT	Safety	CB	IEC 62368-1:2014 and IEC 62368-1:2018; (will issue CB in both versions)
IT	EMC/RF	CE RED 1+UKCA	<p>Video system: Article 3.1a_Health: EN 50663:2017, EN 50665:2017</p> <p>Article 3.1b_EMCC: EN 55032:2015/A11:2020, EN 55035:2017/A11:2020, EN 301 489-1V2.2.3(2019-11) EN 301 489-17V3.24(2020-09)</p> <p>Article 3.2_RF: EN 300 328V2.2.2(2019-07) (2.4G BT RLAN) EN 301 893V2.1.1(2017-05) (5G RLAN band1,2,3: 5150-5250, 5250-5350,5470-5725) EN 300 440V2.1.1 (2017-03) (5G RLAN band4: 5725-5850)</p> <p>Remote control: Article 3.1a_Health: EN 50663:2017</p> <p>Article 3.1b_EMCC: EN 55032:2015/A11:2020, EN 55035:2017/A11:2020, EN 301 489-1V2.2.3(2019-11) EN 301 489-17V3.24(2020-09)</p> <p>Article 3.2_RF: EN 300 328V2.2.2(2019-07) (2.4G BT)</p>
IT	Safety	CE RED UKCA	EN 62368-1:2014 + A11:2017 BS EN 62368-1:2014 + A11:2017
IT	EMC/RF	FCC	<p>Video system: FCC part 15.247, 15.407</p> <p>part2.1091 Part 15B</p> <p>Remote control: FCC part 15.247 part2.1093</p>
IT	EMC/RF	IC	RSS-247, RSS-102
IT	Safety	NRTL (cTUVus) ³	UL 62368-1:2019/R:2021-10, CSA C22.2. No. 62368-1:2019
IT	EMC/RF/Safety	RCM ⁴	AS/NZS 62368.1:2022 AS/NZS CISPR 32-2015+A1-2020; AS/NZS 4268:2017

Medical Equipment Test Standards

Medical	EMC	EMC CNAS test report only (for audio system & remote control)	IEC 60601-1-2:2014/AMD1:2020, EN 60601-1-2:2015/A1:2021 CISPR 11:2015+AMD1:2016+AMD2:2019 EN 55011:2016/A2:2021
Medical	Safety	Safety test report	IEC60601-1:2005+A1:2012+A2:2020 EN60601-1:2006+A1:2013+A12:2014+A2:2021

1. RED: Radio Equipment Directive 2014/53/EU
2. ErP: Energy-Related Products
3. NRTL: Nationally Recognized Testing Laboratory
4. RCM: Regulatory Compliance Mark for AS/NZS

TV Pro 300 Troubleshooting

No Video Showing on Display

- Confirm the display is turned on.
- Make sure the TV Pro 300 is powered on.
- Call Teladoc Health Assistance Center to verify the display is set to the HDMI input that corresponds to where the TV Pro 300 is connected to the display.
- Verify the TV Pro 300 is plugged in fully to the HDMI input. If using the HDMI extension cable, verify both ends are properly connected.

Remote Control Not Responding

- Confirm that remote control low battery indicator is not on.
- Confirm that the remote control is paired.

No Connectivity

Check the Network section of Settings and run the Teladoc Health Network Checkup.

Device Cleaning

Approved Cleaners

The following disinfectants have been tested for compatibility with Teladoc Health devices:

- PDI Bleach Wipes
- OxyCide
- Ethyl Alcohol
- Isopropyl Alcohol
- Sodium Hypochlorite
(5.25%-6.15% household bleach diluted 1:500 provides >100 ppm available chlorine)
- Iodophor Germicidal Detergent Solution
(follow product label for use dilution)
- Quaternary Ammonium Germicidal Detergent Solution
(follow product label for use dilution)

WARNINGS:

- Do not attempt to open or remove any parts of the TV Pro 300.
N'essayez pas d'ouvrir ou de retirer des pièces du TV Pro 300.
- Do not remove any covers to reduce the risk of electric shock. There are no user-serviceable components inside.
ne retirez aucun couvercle pour réduire le risque de choc électrique. Il n'y a aucun composant réparable par l'utilisateur à l'intérieur.
- Wear safety glasses when handling solution prior to dilution.
Porter des lunettes de sécurité lors de la manipulation de la solution avant la dilution.
- Wear rubber or nitrile gloves if in contact with liquid.
Porter des gants en caoutchouc ou en nitrile en cas de contact avec un liquide.
- Avoid contact with eyes, skin and clothing.
Évitez le contact avec les yeux, la peau et les vêtements.
- Wash hands after cleaning device.
Se laver les mains après avoir nettoyé l'appareil.

- Do not wear product-contaminated clothing for prolonged periods.
Ne pas porter de vêtements contaminés par le produit pendant des périodes prolongées.
- Always follow manufacturer's instructions on product labels when mixing chemicals.
Suivez toujours les instructions du fabricant sur les étiquettes des produits lorsque vous mélangez des produits chimiques.
- Ensure a power cord is connected to the AC wall outlet with protective earthing connection.
A Cordon d'alimentation connecté à une prise de courant avec mise à la terre.

CAUTIONS:

- **DO NOT USE** phenolic germicidal detergent solutions on any parts of the device. Contact Teladoc Health Technical Support for approved cleaning solutions.
- Severe contamination may require some disassembly, and this should only be done by a Teladoc Health representative.
- **DO NOT IMMERSE** the device.
- **DO NOT ALLOW** any cleaning solution inside the device.
- Keep the device from moisture and extreme temperatures.
- Avoid excess solution that could enter the device through its openings.

NOTE: Refer to the TV manufacturer for details about cleaning the TV attached to the TV Pro 300.

Pre-cleaning

1. Contact Teladoc Health Technical Support (TAC) at TAC@teladochealth.com or +1 (877) 484-9119 before powering down the device so they can pause monitoring the device.
2. Wear gloves.
3. Power off the TV Pro 300.

Cleaning Instructions

Clean the outer surfaces of the device when visibly soiled or after contact with any contaminants. All surfaces, such as display monitors or sensor windows, may be disinfected using the following procedure. Use a commercial LCD screen cleaner to prevent craze, staining or discoloration of the display monitors and use optical lens cleaners to clean the camera lenses.

1. Power down and unplug the device.
2. Soak a lint-free cloth in a hospital-grade disinfectant solution of sodium hypochlorite 6.15%, e.g., dilution 1:500 (1/4 oz. per gallon water) and wring out the cloth so that drips do not appear when wiping surfaces.
3. Wipe surfaces that have become soiled or contaminated. Avoid applying excess solution, which may enter the device through its openings.
4. Allow to air dry.

Post-cleaning

1. Power on the TV Pro 300.
2. Contact Technical Support (TAC) to let them know cleaning is complete so they can resume monitoring the device.

Contact Information

24/7 Live Technical Support

1-800-484-9119

24/7 Live Remote Technical Support & Live Chat

<https://teladochealth.com/contact>

Email Support

TAC@teladochealth.com

Teladoc Health User Manuals

<https://manuals.intouchcustomer.com>

Sales & Product Demos

1-805-562-8686



Teladoc Health

7406 Hollister Avenue, Goleta, CA 93117

Ph: +1.805.562.8686 • Fax: +1.805.562.8663

RCM Authorized Agent:

ANZ Electrical Compliance

Address: 8 Cootamundra Crescent,
Blackburn, VIC 3130, AUSTRALIA

ABN:76 310 261 826 Responsible

Responsible Supplier Number: E7663

Phone: +61 (0)430 412 380

Postal Address: PO Box 1099,
Blackburn North, VIC 3130, AUSTRALIA



Teladoc Health, Inc. All rights reserved.

Learn More

TeladocHealth.com | engage@teladochealth.com



About Teladoc Health

Teladoc Health is the global virtual care leader, helping millions of people resolve their healthcare needs with confidence. Together with our clients and partners, we are continually modernizing the healthcare experience and making high-quality healthcare a reality for more people and organizations around the world.

© Teladoc Health, Inc. All rights reserved.