

Teladoc Health[®]

TV Pro 300 Cart[™]

User Guide



Model/HVIN: 20-20488

P/N: PL016055.C

© Teladoc Health, Inc. All rights reserved.

Teladoc[®]
HEALTH

Table of Contents

Copyrights	3
Safety Instructions.....	4
Virtual Care System	15
Definition of "Device"	16
Before You Begin	17
TV Pro 300 Cart Visual Overview	18
Wi-Fi Connection Setup.....	21
Power On and Off Sequences.....	24
Settings Menu	25
PTZ Camera Settings.....	28
Request a Virtual Nurse.....	30
Active Session Screen Navigation	32
Device Cleaning.....	33
TV Pro 300 Cart Specifications.....	35
TV Pro 300 Cart Performance Specifications	36
TV Pro 300 Cart Input Power Specifications.....	37
TV Pro 300 Cart Environmental Specifications	38
RF Power Rating and Frequencies	39
TV Pro 300 Cart Electrical and Safety Test Standards	40
Contact Information.....	41

Copyrights

© Teladoc Health, Inc. All rights reserved. This manual contains information including, but not limited to, instructions, descriptions, definitions, firmware and software, which are proprietary to Teladoc Health. Copyright information is protected under Title 17 of the United States Code. This information shall not be copied, modified, or used in any manner that violates any rights of Teladoc Health. We will strictly enforce all of our rights.

Patent(s):

<https://teladochealth.com/patents/>

THIS SOFTWARE IS PROVIDED BY THE COPYRIGHT HOLDERS AND CONTRIBUTORS "AS IS" AND ANY EXPRESS OR IMPLIED WARRANTIES, INCLUDING, BUT NOT LIMITED TO, THE IMPLIED WARRANTIES OF MERCHANTABILITY AND FITNESS FOR A PARTICULAR PURPOSE ARE DISCLAIMED. IN NO EVENT SHALL THE FOUNDATION OR CONTRIBUTORS BE LIABLE FOR ANY DIRECT, INDIRECT, INCIDENTAL, SPECIAL, EXEMPLARY, OR CONSEQUENTIAL DAMAGES (INCLUDING, BUT NOT LIMITED TO, PROCUREMENT OF SUBSTITUTE GOODS OR SERVICES; LOSS OF USE, DATA, OR PROFITS; OR BUSINESS INTERRUPTION) HOWEVER CAUSED AND ON ANY THEORY OF LIABILITY, WHETHER IN CONTRACT, STRICT LIABILITY, OR TORT (INCLUDING NEGLIGENCE OR OTHERWISE) ARISING IN ANY WAY OUT OF THE USE OF THIS SOFTWARE, EVEN IF ADVISED OF THE POSSIBILITY OF SUCH DAMAGE.

Microsoft® and Windows® are either registered trademarks or trademarks of Microsoft Corporation in the U.S. and/or other countries.

Last updated: October 2024

Safety Instructions

Users of the system require clinical judgment and experience to review and interpret the patient data transmitted.

Notes, Cautions and Warnings

The types of safety instructions are:





NOTE: Supplementary information to facilitate the operation of the system.







CAUTION: Instructions for avoiding damage to the system.

WARNING: Information may prove hazardous to the safety of a person near the Teladoc Health Patient Access device.

Safety Symbols

Symbols appearing on the Patient Access device and other equipment are defined in the table below.

<p>Wireless Transmitter Notification: Non-ionizing electromagnetic radiation. This device communicates over the 802.11 ac/a/b/g/n standard for wireless communication.</p>	
<p>Do Not Dispose of in Household Waste: This symbol explains that you should not place the electrical item in the general waste.</p>	
<p>FCC: The FCC mark is a voluntary mark employed on electronic products manufactured or sold in the United States which indicates that the electromagnetic radiation from the device is below the limits specified by the Federal Communications Commission and the manufacturer has followed the requirements of the Supplier's Declaration of Conformity authorization procedures.</p>	
<p>Manufacturer: This symbol shall be accompanied by the name and address of the manufacturer.</p>	

<p>Date of Manufacture: This symbol shall be accompanied by a date to indicate the date of manufacture.</p>	
<p>TUV Mark - This test mark is proof of compliance with Canadian National standards and U.S. National standards. It demonstrates an electrical product has been successfully tested and certified by a Certification Body accredited by the Standards Council of Canada (SCC) and by a Nationally Recognized Testing Laboratory (NRTL) accredited by the Occupational Safety and Health Administration (OSHA).</p>	
<p>Consult Operator's Manual: Operating Instructions are contained in a separate instruction manual.</p>	
<p>Do Not Push or Lean: Do not push on cart when it is prevented from lateral movement by an obstruction.</p>	
<p>CE Label: On commercial products, the letters CE mean that the manufacturer or importer affirms the good's conformity with European health, safety and environmental protection standards.</p>	
<p>UKCA Label: The UKCA marking is the product marking used for products being placed on the market in Great Britain (England, Scotland and Wales).</p>	

Proposition 65: State of California: The law requires California to publish a list of chemicals known to cause cancer or reproductive toxicity, and for businesses with 10 or more employees to provide warnings when they knowingly and intentionally cause significant exposures to listed chemicals.



WARNING: This product can expose you to chemicals including Diisononyl Phthalate, which is known to the State of California to cause cancer, and Bisphenol A, which is known to the State of California to cause birth defects or other reproductive harm. For more information, go to www.P65Warnings.ca.gov.

FCC Warning

WARNINGS:

This equipment has been tested and found to comply with the limits for a Class A digital device, pursuant to part 15 of the FCC Rules. These limits are designed to provide reasonable protection against harmful interference when the equipment is operated in a commercial environment. This equipment generates, uses and can radiate radio frequency energy and, if not installed and used in accordance with the instruction manual, may cause harmful interference to radio communications. Operation of this equipment in a residential area is likely to cause harmful interference in which case the user will be required to correct the interference at their own expense.

Cet équipement a été mis à l'essai et déclaré conforme aux limites d'un appareil numérique de classe A, conformément à la partie 15 des règles de la FCC. Ces limites sont conçues pour fournir une protection raisonnable contre les interférences nuisibles lorsque l'équipement est utilisé dans un environnement commercial. Cet équipement génère, utilise et peut émettre des fréquences radio et, s'il n'est pas installé et utilisé conformément au manuel d'instructions, peut causer des interférences nuisibles aux communications radio. L'utilisation de cet appareil dans une zone résidentielle est susceptible de provoquer des effets nocifs sur la santé. dans lequel cas l'utilisateur devra corriger l'interférence à ses propres frais.

The device supports the 5 GHz U-NII 1 frequency band, which is 5.150 to 5.250 GHz. It will be restricted for use in the indoor environment only.

L'appareil prend en charge la bande de fréquence U-NII 1 de 5 GHz, qui va de 5,150 à 5,250 GHz. Son utilisation sera limitée à l'intérieur des bâtiments.

Telehealth Communications system should be installed and operated with minimum distance of 20 cm between the radiator and your body.

Le système de communication pour la télésanté doit être installé et utilisé en respectant une distance minimale de 20 cm entre le radiateur et votre corps.

The device complies with part 15 of the FCC Rules. Operation is subject to the following two conditions: (1) This device may not cause harmful interference, and (2) this device must accept any interference received, including interference that may cause undesired operation.

L'appareil est conforme à la partie 15 des règles de la FCC. Le fonctionnement est soumis aux deux conditions suivantes : (1) cet appareil ne doit pas causer d'interférences nuisibles, et (2) cet appareil doit accepter toute interférence reçue, y compris les interférences susceptibles de provoquer un fonctionnement indésirable.

MODIFICATION: Any changes or modifications not expressly approved by the grantee of this device could void the user's authority to operate the device.

MODIFICATION: Tout changement ou toute modification non expressément approuvé par le bénéficiaire de cet appareil peut annuler l'autorisation de l'utilisateur à faire fonctionner l'appareil.

Radio Equipment Directive (RED)

TV Pro 300 Cart includes wireless communication functions (e.g., Bluetooth LE, Wi-Fi and RF) in the Bluetooth remote control, Bluetooth dongle, and Wi-Fi/BT module of the main board. The RF power rating and operating frequencies are as follows:

- Remote control and Bluetooth dongle
 - RF power is <2 dBm
 - RF operating frequency: 2402-2480 MHz
- Intel AX210 on i3 board
 - RF power is <20 dBm
 - RF operating frequency: 2400-2483.5 MHz, 5150-5350 MHz, 5470-5725 MHz, 5745-5825 MHz

Hereby, Teladoc Health declares that the radio equipment type Telehealth Communications System is in compliance with Directive 2014/53/EU. The full text of the EU declaration of conformity is available by clicking here: [Full Declaration of Conformity](#)

IC Warnings

English Version

The device supports 5GHz U-NII 1 frequency band, which is 5.150 to 5.250 GHz. It will be restricted for indoor use only.

Telehealth Communications System complies with IC radiation exposure limits set forth for a controlled environment. This equipment should be installed and operated with minimum distance of 20 cm between the radiator and your body.

This device contains license-exempt transmitter(s)/receiver(s) that comply with Innovation, Science and Economic Development Canada's license-exempt RSS(s). Operation is subject to the following two conditions:

1. This device may not cause interference.
2. This device must accept any interference, including interference that may cause undesired operation of the device.

Version française

L'appareil prend en charge la bande de fréquences 5 GHz U-NII 1, qui est de 5 150 à 5 250 GHz. Il ne sera utilisé qu'à l'intérieur.

Telehealth Communications System est conforme aux limites d'exposition aux rayonnements de la IC établies pour un environnement non contrôlé. Cet équipement doit être installé et fonctionner à au moins 20 cm de distance du radiateur ou de votre corps.

L'émetteur/récepteur exempt de licence contenu dans le présent appareil est conforme aux CNR d'Innovation, Sciences et Développement économique Canada applicables aux appareils radio exempts de licence. Le fonctionnement est autorisé selon les deux conditions suivantes :

1. L'appareil ne doit pas produire d'interférences.
2. L'appareil doit accepter toute interférence radioélectrique subie, même si

Electromagnetic Compatibility

Guidance and Manufacturer's Declaration

The TV Pro 300 Cart system complies with IEC 60601-1-2 4th edition, General Requirements for Safety — Collateral standard: Electromagnetic compatibility. Performance of the device is unaffected by exposure to the compliance levels described in Tables 1, 2, 3 and 4 in the following section.

Special precautions and installation information for the TV Pro 300 Cart for electromagnetic compatibility (EMC) are provided below:

- Equipment in hospital environments, including the TV Pro 300 Cart and other portable or mobile communications equipment, can produce Electromagnetic Interference (EMI), that may affect the function of these devices. Such effects are prevented by use of equipment with EMI characteristics proven below recognized limits, as identified in the tables below.
- In the event of suspected interference from other equipment, which prevents the proper functioning of the TV Pro 300 Cart, contact Teladoc Health and discontinue use of the system until the problem can be remedied.

The following tables contain the Manufacturer's declaration and additional information required by IEC 60601-1-2.

IEC 60601-1-2:2014/AMD1:2020 ME EQUIPMENT and ME SYSTEMS identification, marking and documents for Class A product

The ME EQUIPMENT or ME SYSTEM is suitable for professional healthcare facility.

WARNINGS:

- Don't install near active HF surgical equipment and the RF shielded room of an ME system for magnetic resonance imaging, where the intensity of EM disturbances is high.

N'installez pas l'appareil à proximité d'équipements chirurgicaux HF actifs et de la salle blindée RF d'un système ME pour l'imagerie par résonance.

- Use of this equipment adjacent to or stacked with other equipment should be avoided because it could result in improper operation. If such use is necessary, this equipment and the other equipment should be observed to verify that they are operating normally.

L'utilisation de cet appareil à côté ou empilé avec d'autres appareils doit être évitée car elle pourrait entraîner un mauvais fonctionnement. Si une telle utilisation est nécessaire, cet équipement et les autres équipements doivent être observés pour vérifier qu'ils fonctionnent normalement.

- Use of accessories, transducers and cables other than those specified or provided by the manufacturer of this equipment could result in increased electromagnetic emissions

or decreased electromagnetic immunity of this equipment and result in improper operation.

L'utilisation de cet équipement à côté ou combiné avec d'autres équipements doit être évitée, car cela pourrait entraîner un mauvais fonctionnement. Si une telle utilisation est nécessaire, cet équipement et les autres équipements doivent être observés afin de vérifier qu'ils fonctionnent normalement.

- Portable RF communications equipment (including peripherals such as antenna cables and external antennas) should be used no closer than 30 cm (12 inches) to any part of the audio/video communication system (TV Pro 300 Cart), including cables specified by the manufacturer. Otherwise, degradation of the performance of this equipment could result.

Les équipements de communication RF portables (y compris les périphériques tels que les câbles d'antenne et les antennes externes) ne doivent pas être utilisés à moins de 30 cm de toute partie du système de communication audio/vidéo (TV Pro 300 Cart), y compris les câbles spécifiés par le fabricant. Dans le cas contraire, les performances de l'appareil pourraient se dégrader.

- To avoid the risk of electric shock, this equipment must only be connected to a supply mains with protective earth.

Pour éviter tout risque d'électrocution, cet équipement ne doit être branché qu'à une alimentation secteur avec mise à la terre de protection.

NOTE: Teladoc recommends the use of the HDMI and power cables included with the product. The user is responsible for additional cables and connections made to TV Pro 300 Cart.

Table 1: Electromagnetic Emissions

1. All necessary instructions for maintaining BASIC SAFETY and ESSENTIAL PERFORMANCE with regard to electromagnetic disturbances for the expected service life.
2. Guidance and manufacturer's declaration -electromagnetic emissions and Immunity.

The TV Pro 300 Cart is intended for use in the electromagnetic environment specified below. The customer or the user of the TV Pro 300 Cart should assure that it is used in such an environment.

Emissions Test	Compliance
RF Emissions CISPR 11	Group 1
RF Emissions CISPR 11	Class A
Harmonic Emissions IEC 61000-3-2	Class A
Voltage Fluctuations / Flicker Emissions IEC 61000-3-3	Complies

Table 2: Electromagnetic Immunity

The TV Pro 300 Cart system is intended for use in the electromagnetic environment specified below. The customer or the user of the TV Pro 300 Cart should assure that it is used in such an environment.

CAUTION: An Electro Static Discharge (ESD) event may cause the system to lose functionality for a short amount of time. If the event does not recover automatically, power cycle the device.

Immunity Test	IEC 60601-1-2 Test Level	Compliance Level	Electromagnetic Environment - Guidance
Electrostatic Discharge (ESD) IEC 61000-4-2	±8 kV contact ±2 kV, ±4 kV, ±8 kV, ±15 kV air	±8 kV contact ±2 kV, ±4 kV, ±8 kV, ±15 kV air	Floors should be wood, concrete or ceramic tile. If floors are covered with synthetic material, the relative humidity should be at least 30%.
Electrical Fast Transient / Burst IEC 61000-4-4	Power supply lines: ±2 kV 100 kHz repetition frequency	Power supply lines: ±2 kV 100 kHz repetition frequency	Mains power quality should be that of a typical commercial or hospital environment.
Surge IEC 61000-4-5	line(s) to line(s): ±1 kV.	line(s) to line(s): ±1 kV.	Mains power quality should be that of a typical commercial or hospital environment.
Voltage Dips, Short Interruptions, and Voltage Variations on Power Supply Input Lines IEC 61000-4-11	0% 0.5 cycle At 0°, 45°, 90°, 135°, 180°, 225°, 270° and 315° 0% 1 cycle And 70% 25/30 cycles Single phase: at 0 0% 300 cycle	0% 0.5 cycle At 0°, 45°, 90°, 135°, 180°, 225°, 270° and 315° 0% 1 cycle And 70% 25/30 cycles Single phase: at 0 0% 300 cycle	Mains power quality should be that of a typical commercial or hospital environment. If the user of the device requires continued operation during power mains interruptions, it is recommended that the Lite 4 with Boom Camera be powered from an uninterruptible power supply (UPS) or a battery.
Power frequency Magnetic Field IEC 61000-4-8	30 A/m 50Hz/60Hz	30 A/m 50Hz/60Hz	Power frequency magnetic fields should be at levels characteristic of a typical location in a typical commercial or hospital environment.

Immunity Test	IEC 60601-1-2 Test Level	Compliance Level	Electromagnetic Environment - Guidance
Conducted RF IEC61000-4-6	150KHz to 80MHz: 3Vrms 6Vrms (ISM bands between) 80% Am at 1kHz	150KHz to 80MHz: 3Vrms 6Vrms (ISM bands between) 80% Am at 1kHz	<p>Portable and mobile RF communications equipment should be used no closer to any part of the TV Pro 300 Cart, including cables, than the recommended separation distance calculated from the equation applicable to the frequency of the transmitter. Recommended separation distance:</p> $d = 1.2 \sqrt{P}$ <p>80 MHz to 800 MHz</p> $d = 1.2 \sqrt{P}$ <p>800 MHz to 2.5 GHz</p> $d = 2.3 \sqrt{P}$ <p>where P is the maximum output power rating of the transmitter in watts (W) according to the transmitter manufacturer and d is the recommended separation distance in meters (m). Field strengths from fixed RF transmitters, as determined by an electromagnetic site survey^a, should be less than the compliance level in each frequency range^b.</p> <p>Interference may occur in the vicinity of equipment marked with the following symbol:</p> 
Radiated RF IEC61000-4-3	3 V/m 80 MHz – 2,7 GHz 80 % AM at 1 kHz	3 V/m 80 MHz – 2,7 GHz 80 % AM at 1 kHz	
Proximity magnetic fields IEC 61000-4-39	30 kHz: 8A/m 134.2 kHz: 65A/m 13.56 MHz: 7.5A/m	Not application Or 30 kHz: 8A/m 134.2 kHz: 65A/m 13.56 MHz: 7.5A/m	

U_T is the a.c. mains voltage prior to application of the test level.

Table 3: Electromagnetic Immunity - Enclosure Port Immunity

TV Pro 300 Cart is intended for use in the electromagnetic environment specified below. The customer or the user of an TV Pro 300 Cart should assure that it is used in such an environment.

Guidance and manufacturer's declaration - electromagnetic Immunity								
Radiated RF IEC61000-4-3 (Test specifications for ENCLOSURE PORT IMMUNITY to RF wireless communications equipment)	Test Frequency (MHz)	Band (MHz)	Service	Modulation	Maximum Power(W)	Distance (m)	IEC 60601-1-2 Test level (V/m)	Compliance level (V/m)
	385	380 – 390	TETRA 400	Pulse modulation 18 Hz	1,8	0.3	27	27
	450	430– 470	GMRS 460, FRS 460	FM ± 5 kHz deviation 1 kHz sine	2	0.3	28	28
	710	704 – 787	LTE Band 13, 17	Pulse modulation 217 Hz	0,2	0.3	9	9
	745							
	780							
	810	800 – 960	GSM 800/900, TETRA 800, iDEN 820, CDMA 850, LTE Band 5	Pulse modulation 18 Hz	2	0.3	28	28
	870							
	930							
	1720	1 700 – 1 990	GSM 1800; CDMA 1900; GSM 1900; DECT; LTE Band 1, 3, 4, 25; UMTS	Pulse modulation 217 Hz	2	0.3	28	28
	1845							
	1970							
	2450	2 400 – 2 570	Bluetooth, WLAN, 802.11 b/g/n, RFID 2450, LTE Band 7	Pulse modulation 217 Hz	2	0.3	28	28
	5240	5 100 – 5 800	WLAN 802.11 a/n	Pulse modulation 217 Hz	0,2	0.3	9	9
5500								
5785								

Table 4: Recommended separation distances

Recommended separation distances between portable and mobile RF communications equipment and the TV Pro 300 Cart.

The TV Pro 300 Cart is intended for use in an electromagnetic environment in which radiated RF disturbances are controlled. The customer or the user of the TV Pro 300 Cart can help prevent electromagnetic interference by maintaining a minimum distance between portable and mobile RF communications equipment (transmitters) and the TV Pro 300 Cart as recommended below, according to the maximum output power of the communications equipment.

Guidance and manufacturer's declaration - electromagnetic Immunity		
Test frequency	Modulation	Immunity Test Level (A/m)
30 kHz	CW	8
134,2 kHz	Pulse modulation ^a 2,1 kHz	65 ^b
13,56 MHz	Pulse modulation ^a 50 kHz	7,5 ^b

a) The carrier shall be modulated using a 50% duty cycle square wave signal.
b) r.m.s., before modulation is applied.

For transmitters rated at a maximum output power not listed above, the recommended separation distance d in meters (m) can be estimated using the equation applicable to the frequency of the transmitter, where P is the maximum output power rating of the transmitter in watts (W) according to the transmitter manufacturer.

NOTES

1. At 80 MHz and 800 MHz, the separation distance for the higher frequency range applies.
2. These guidelines may not apply in all situations. Electromagnetic propagation is affected by absorption and reflection from structures, objects and people.

Virtual Care System

Health systems view virtual care as an extension of their services, relying on a combination of software, hardware, networks, systems and people to work together to deliver improved access and care to their patients.

Enabling healthcare's only integrated virtual care platform, Teladoc Health powers virtual encounters at clinics, healthcare facilities and patient homes for an integrated experience across a multitude of use cases. Built on our cloud-based network, Solo™ is the backbone to delivering care anywhere at any time. It provides users with everything they need to streamline their telehealth needs for fast user adoption.

Designed for healthcare, security and reliability

Our cloud-based, patented network ensures the industry's highest standards for protecting and securing sensitive healthcare information. Our downloadable and web-based platform allows users to access virtual care across a broad range of consumer and telehealth devices in a variety of clinical environments.

Definition of “Device”

Use of the word “device(s)” in this User Guide refers to Teladoc Health telehealth products, not medical devices as defined in Section 201(h) of the Federal Food, Drug, and Cosmetic Act (FD&C) Act.

In addition, the term “mobile devices” refers to smartphones and tablets.

Before You Begin

The TV Pro 300 Cart should be installed by an IT professional to ensure proper setup and network configuration.

Before setting up your TV Pro 300 Cart, review the Teladoc Health Telehealth Network Specifications document (MB-14011) to configure your network to optimize the telehealth consultation experience. If you do not have the Teladoc Health Telehealth Network Specifications document, please contact your local Teladoc Health Product Specialist.

It is not recommended that the TV Pro 300 Cart be shutdown, but if shut down is required, follow the procedure “TV Pro 300 Cart Power Off Sequence” on page 22.

Intended Use

The Teladoc Health TV Pro 300 Cart is intended to provide high-quality, HIPAA-compliant audio and video sessions between a provider and a patient over the Teladoc Health Telehealth Network.

- Trained healthcare professionals are the intended users of the Teladoc Health TV Pro 300 Cart. Users of the system require clinical judgment and experience to review and interpret the patient data transmitted.
- Teladoc Health TV Pro 300 Cart is intended to be used in the Professional Healthcare Facility environment.

General Ecosystem Requirements

- Access to a clinical Wi-Fi network or LAN
- USB keyboard and mouse for easy installation

TV Pro 300 Cart Overview

TV Pro 300 Cart is an integrated telehealth product that allows for a two-way virtual consult. Because TV Pro 300 Cart is equipped with two night vision cameras, remote physicians can clearly examine the patient at any time of the day.

TV Pro 300 Cart Visual Overview

Front, Back, and Side View



TV Pro 300 Cart Features

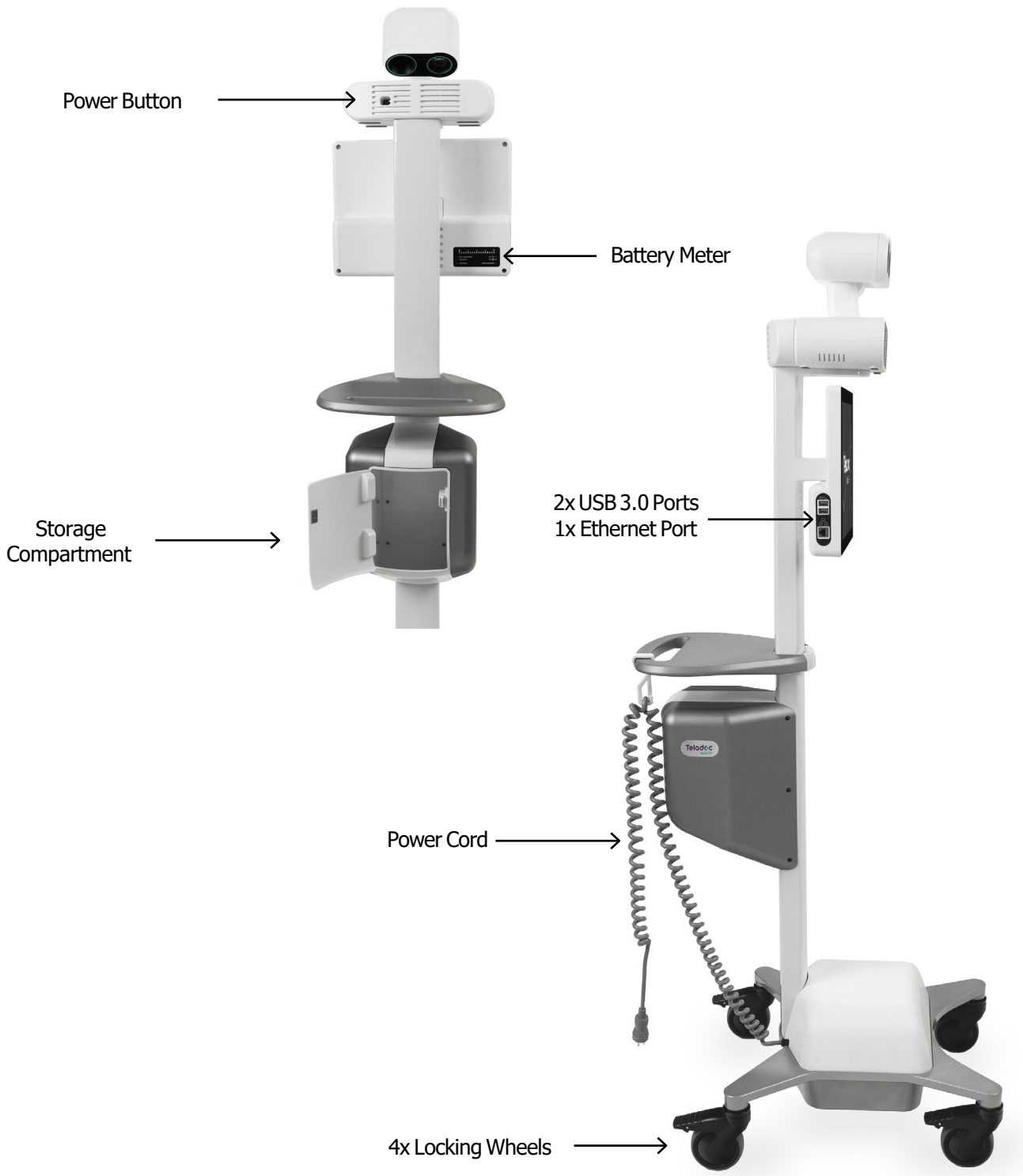

Interactive Components



Wi-Fi Connection Setup

NOTE:

- Advanced Wi-Fi set up should be done only by a trained technician.

1. Press "Ctrl - Shift - Space" on the keyboard to bring up Debug mode.
2. Click the "X" at the top-right of the window to close the Robot software.

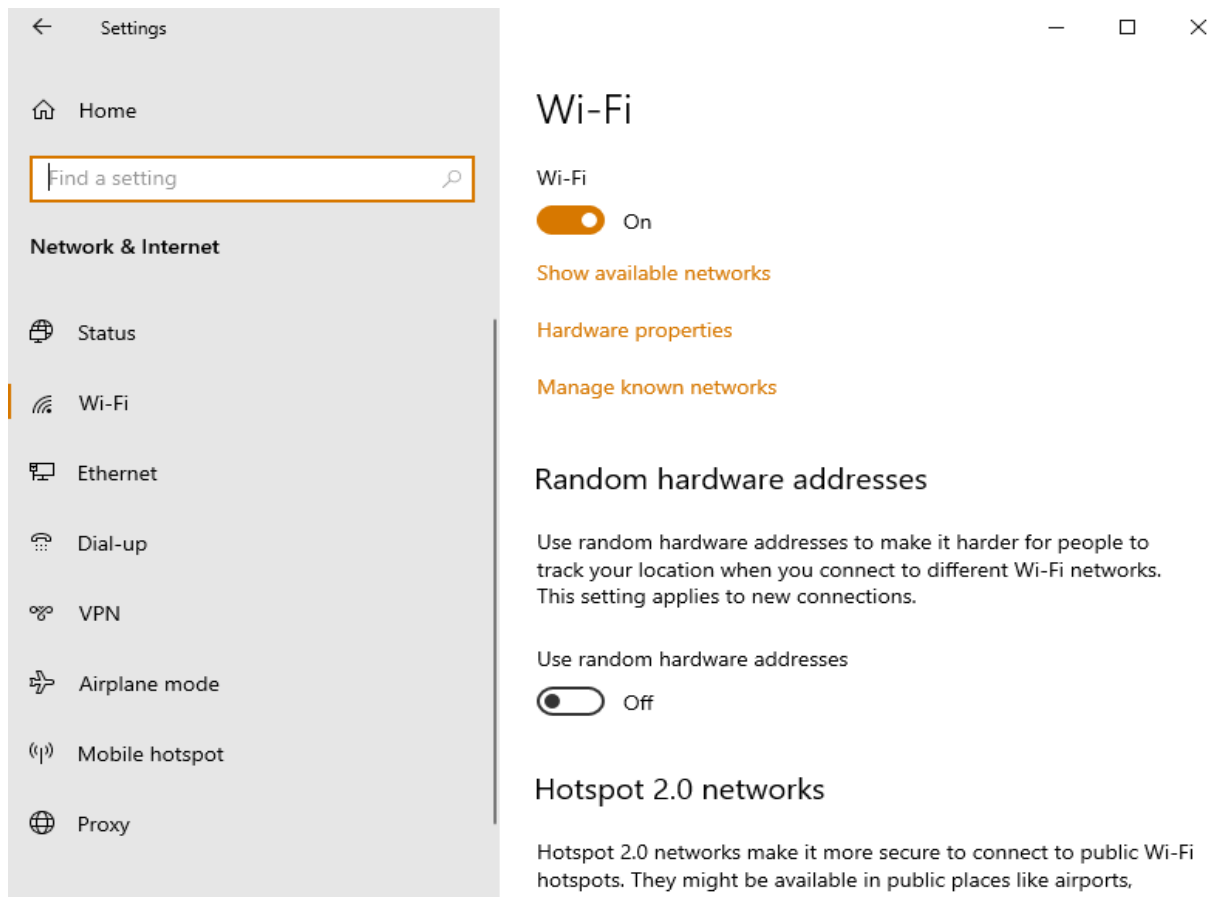
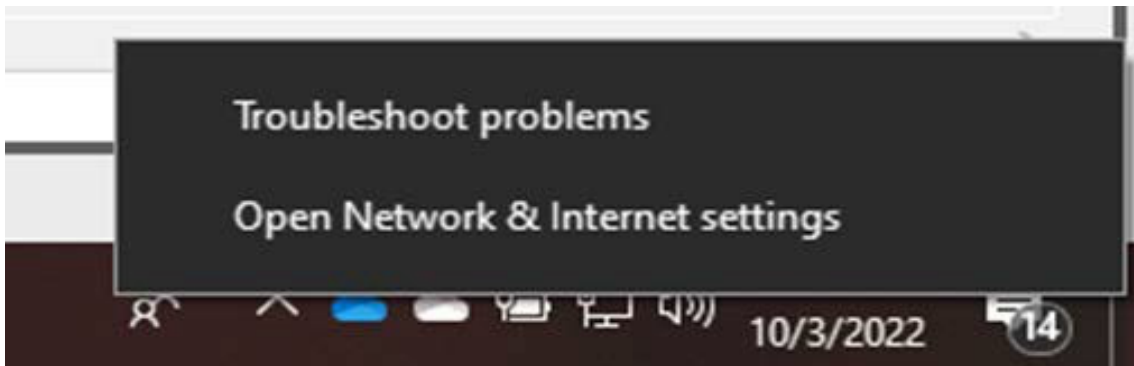

Wi-Fi

Manage known networks

+ Add a new network

Search this list 🔍

Sort by: Preference ▾ Filter by: All ▾

Some settings are managed by your system administrator.

📶 TDH Secure
Added by company policy

📶 InterContinental





Properties Forget

📶 NETGEAR21

📶 NotSuddenStink

← Set Up a Connection or Network

Choose a connection option

-  **Connect to the Internet**
Set up a broadband or dial-up connection to the Internet.
-  **Set up a new network**
Set up a new router or access point.
-  **Manually connect to a wireless network**
Connect to a hidden network or create a new wireless profile.
-  **Connect to a workplace**
Set up a dial-up or VPN connection to your workplace.

Next

Cancel

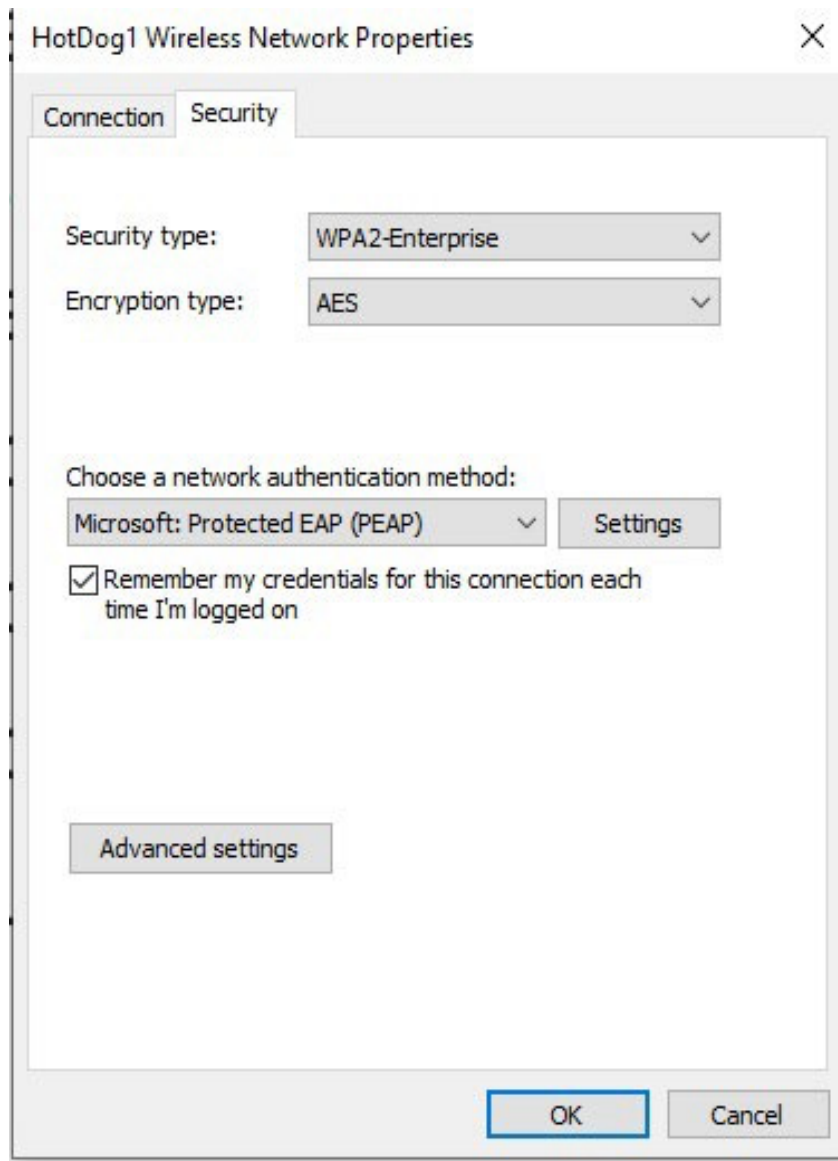

Power On and Off Sequences

Power On Sequence

1. Connect the TV Pro 300 Cart to a power outlet. The device will take approximately 2 minutes to initialize.
2. Connect the TV Pro 300 Cart to the wall Ethernet port or use Wi-Fi.
 - a. The TV Pro 300 Cart will automatically power on and log in to the runtime account.
 - b. The Teladoc Health application will start automatically as shown by the screensaver.



Power Off Sequences

Graceful Shutdown

1. Press and release the Reset button on the back to gracefully shut down the device.
2. AC power can be disconnected from the device after shutdown.

Hard Shutdown

1. Press and hold the Reset button on the back for a hard shutdown.
2. AC power can be disconnected from the device after shutdown.

Settings Menu

Press anywhere on the display to show the settings menu.

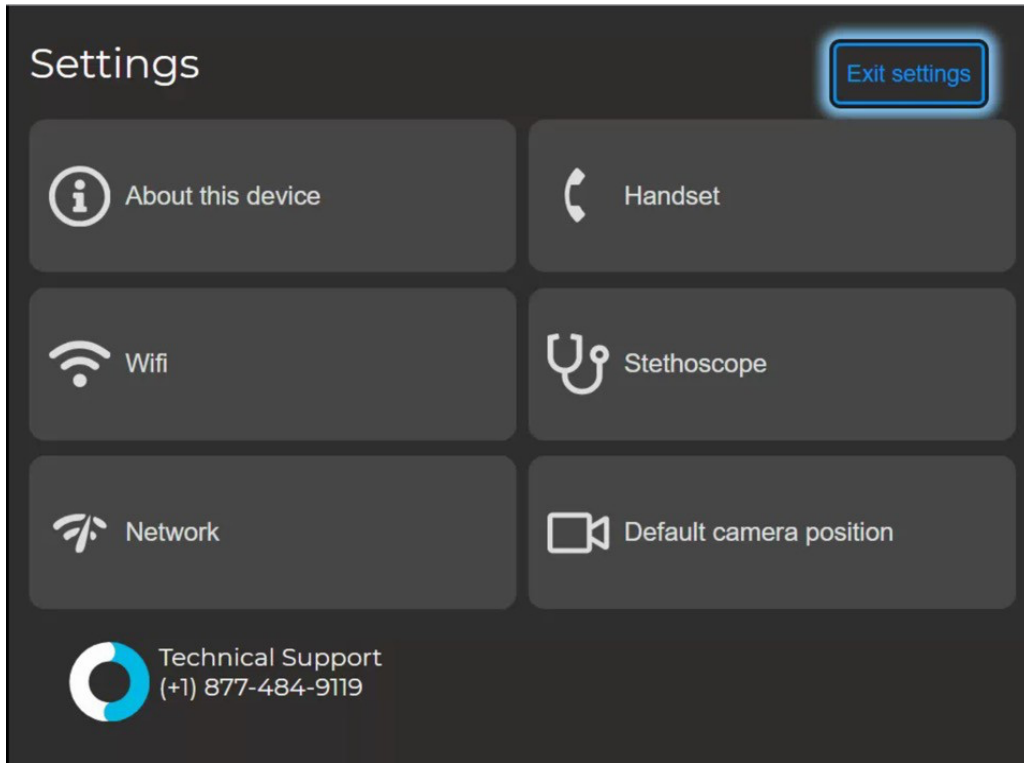

About this device

Shows the status and various support information about the device.



Network

Shows the hospital internet connectivity and allows the user to run a checkup on the Teladoc Health network status.

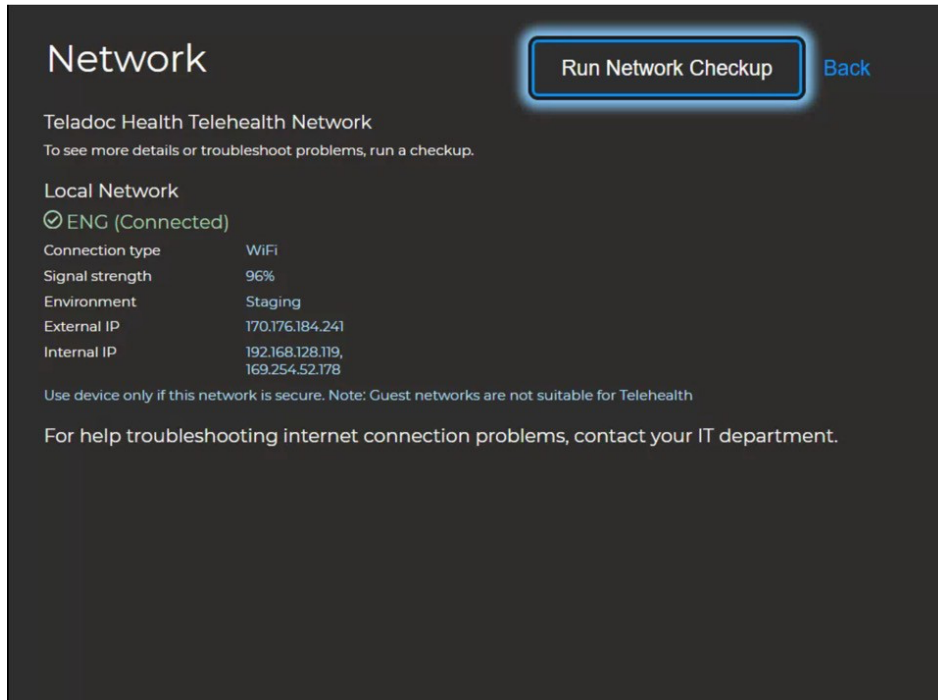

If you would like to run a check on the network, click [Run Network Checkup](#). The system will run a check and report back. If you'd like to check again, click [Run Another Checkup](#).

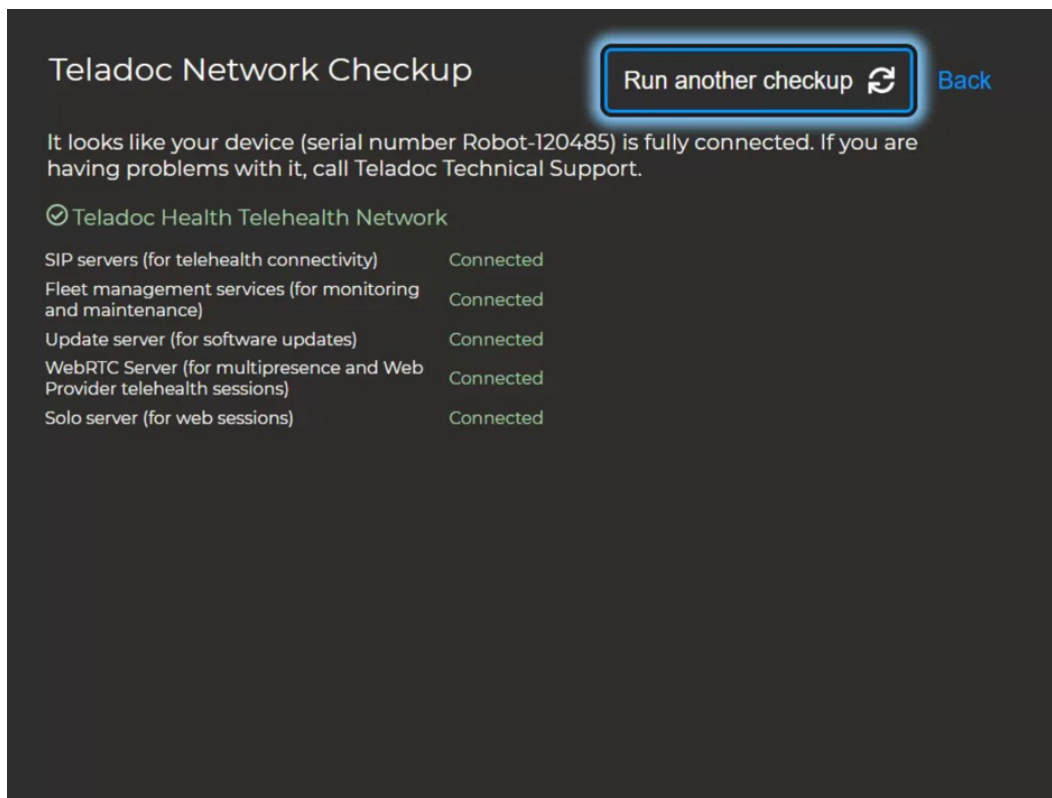

Stethoscope

Allows the user to connect and select a Bluetooth stethoscope if needed.

NOTE: The TV Pro 300 Cart does not require a stethoscope for use.

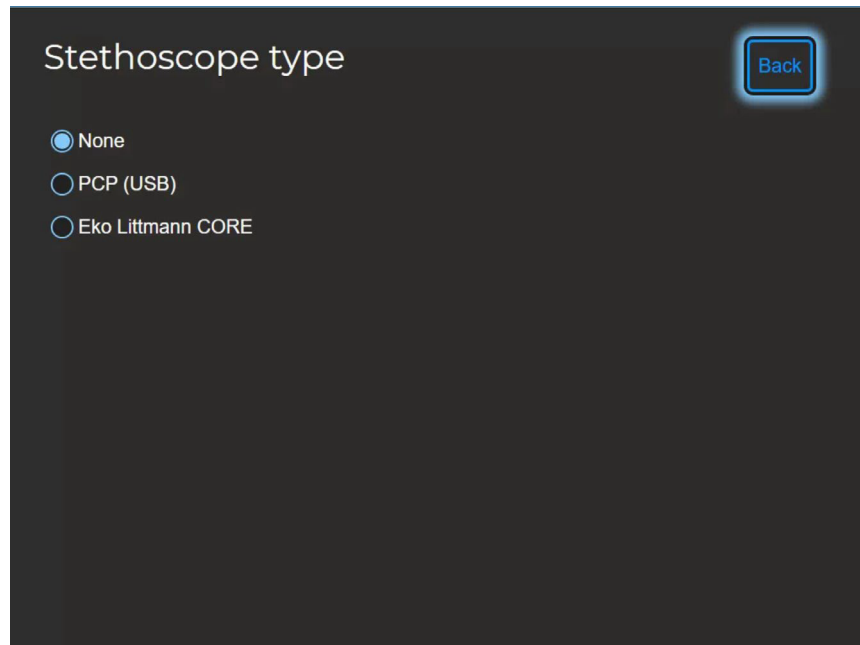

Default camera position

Allows the user to preset the direction the camera is facing in and out of a virtual session.

After selecting [Default camera position](#), the user will first see Fixed camera view. Previewing the Fixed camera view (denoted as Wide Angle) will allow the user to adjust the tilt of the mount if needed.



The user can select the Main camera or the Wide Angle camera.

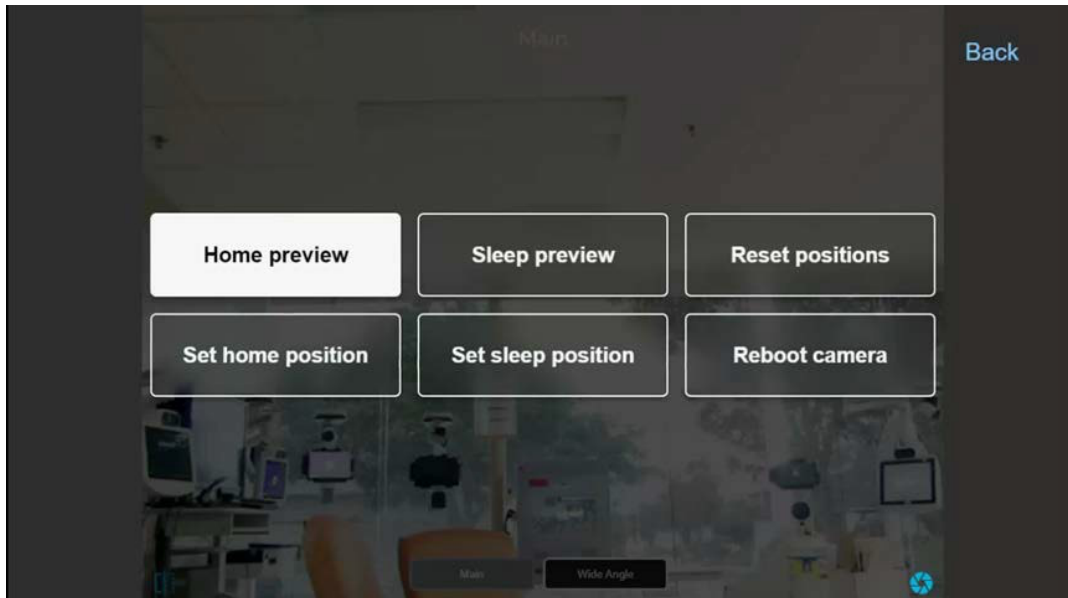

PTZ Camera Settings

The user can select the shutter icon on the bottom right corner to reveal the six buttons relating to the PTZ camera.

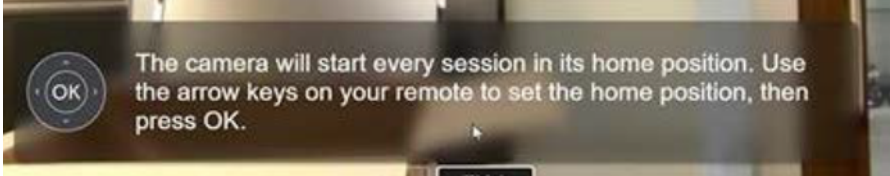

Button	Function
Home preview	Allows the user to preview the home position, which is the camera position during a virtual session.
Set home position	Allows the user to set the home camera position. When this button is pressed, a message will inform the user how to set that with the remote control. <div style="text-align: center;">   </div>
Sleep preview	Allows the user to preview the sleep position, which is the camera position when there is no virtual session.
Set sleep position	Allows the user to set the sleep camera position. When this button is pressed, a message will inform the user how to set that with the remote control.

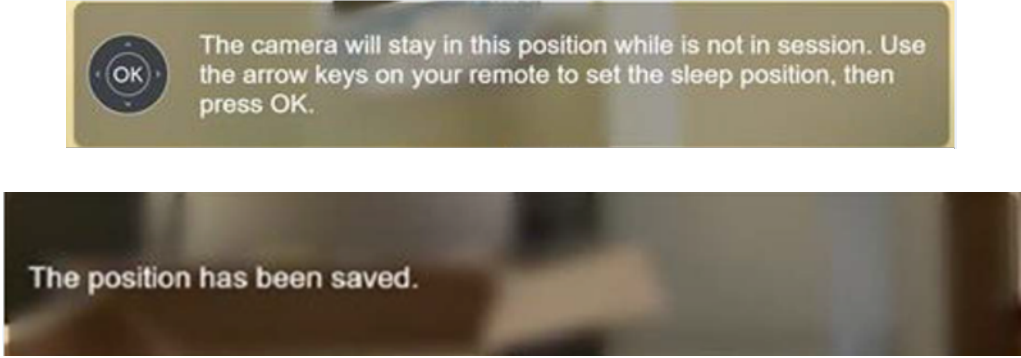
	
Reset positions	Reset the PTZ camera.
Reboot camera	Reboot PTZ camera – cycles the PTZ camera’s power.

Request a Virtual Nurse

Using the touchscreen, go to the Virtual Nurse home screen.

Click Request a Virtual Nurse

This will open the Request video call screen.

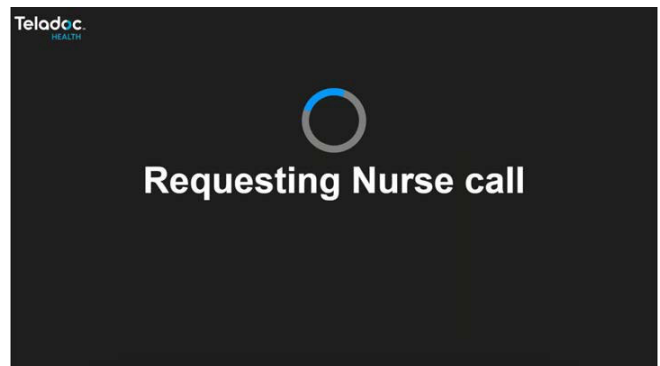
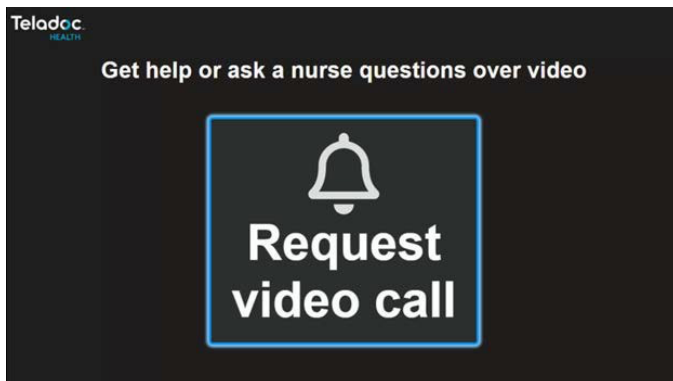

The Request Sent loading screen will display while you wait for a nurse to connect.

From the Request Sent screen, there is an option to Cancel request, which you can do at any time as you wait.

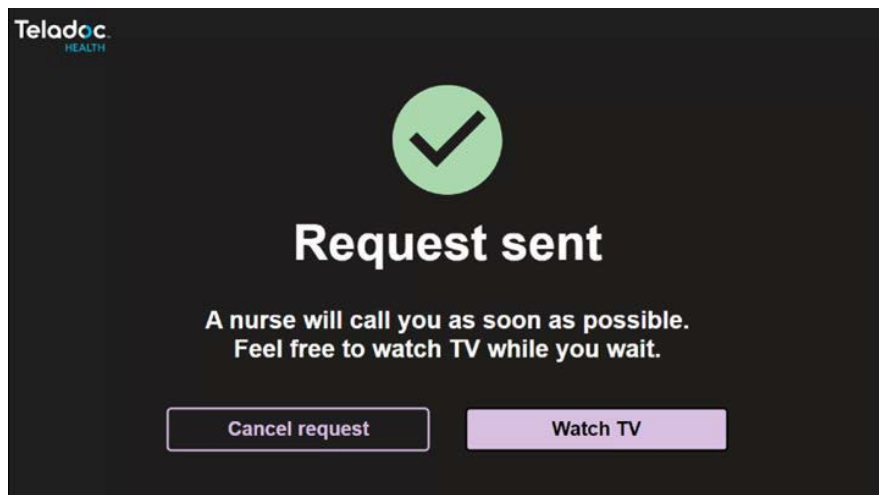

When the Virtual Nurse call is getting ready to begin, the following screen will display

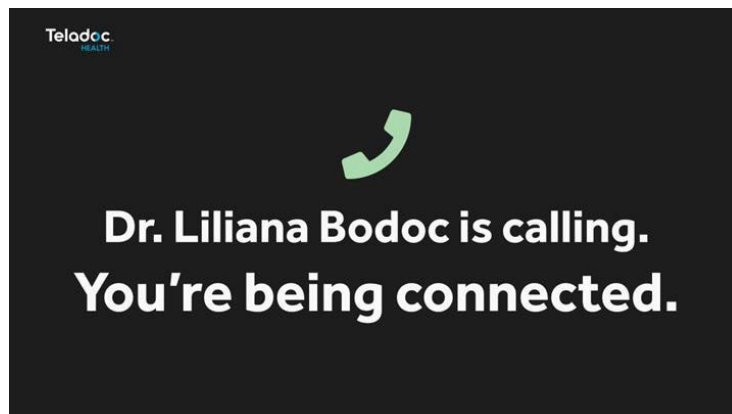

Active Virtual Nurse Video Call

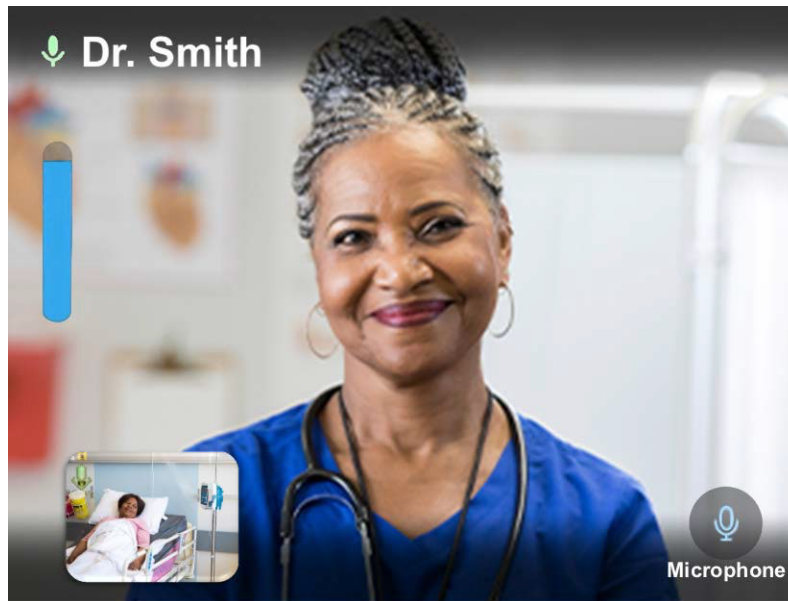



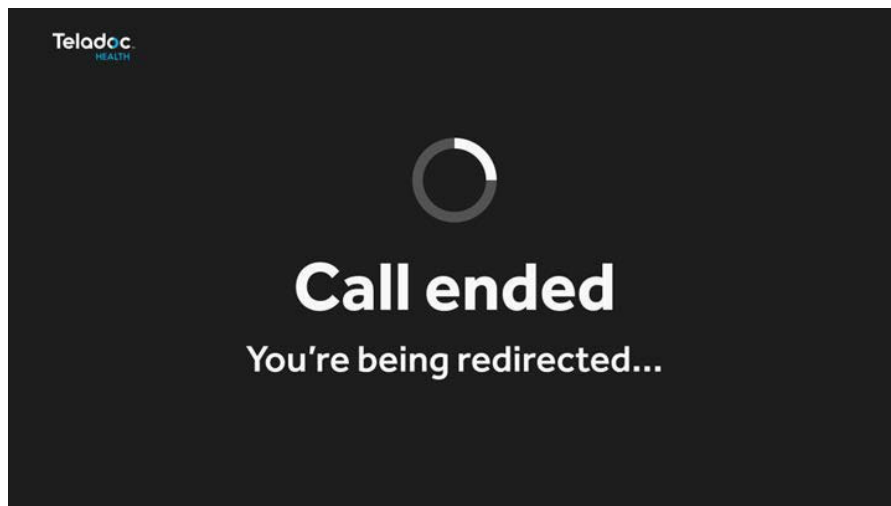

The following screen displays when the call is ended.



Active Session Screen Navigation

When a Virtual Care session is in progress, a toolbar similar to the one below is displayed.

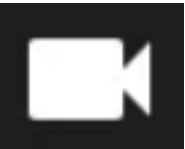

Icon	Function
	<p>Volume control: Move slider to adjust device's volume. Mute the local volume by dragging the slider to the left or pressing the left-most speaker icon.</p>
	<p>Mutes the device's microphone; tap again to un-mute.</p>
	<p>Turns on and off the video.</p>
	<p>Toggles the Picture-in-Picture.</p>
	<p>Ends the current remote session. A confirmation box will display before the remote session is ended.</p>

Device Cleaning

Pre-cleaning

1. Contact Teladoc Health Technical Support (TAC) at TAC@teladochealth.com or +1 (877) 484-9119 before powering down the device so they can pause monitoring the device.
2. Wear gloves.
3. Power off the TV Pro 300 Cart.

Cleaning Instructions

Clean the outer surfaces of the device when visibly soiled or after contact with any contaminants. All surfaces, such as display monitors or sensor windows, may be disinfected using the following procedure. Use a commercial LCD screen cleaner to prevent craze, staining or discoloration of the display monitors and use optical lens cleaners to clean the camera lenses.

1. Power down and unplug the device.
2. Soak a lint-free cloth in a hospital-grade disinfectant solution of sodium hypochlorite 6.15%, e.g., dilution 1:500 (1/4 oz. per gallon water) and wring out the cloth so that drips do not appear when wiping surfaces.
3. Wipe surfaces that have become soiled or contaminated. Avoid applying excess solution, which may enter the device through its openings.
4. Allow to air dry.

Approved Cleaners

The following disinfectants have been tested for compatibility with Teladoc Health devices:

- PDI Bleach Wipes
- OxyCide
- Ethyl Alcohol
- Isopropyl Alcohol
- Sodium Hypochlorite (5.25%-6.15% household bleach diluted 1:500 provides >100 ppm available chlorine)
- Iodophor Germicidal Detergent Solution (follow product label for use dilution)
- Quaternary Ammonium Germicidal Detergent Solution (follow product label for use dilution)

Post-cleaning

1. Power on the TV Pro 300 Cart.
2. Contact Technical Support (TAC) to let them know cleaning is complete so they can resume monitoring the device.

Device Cleaning Cautions and Warnings

CAUTIONS:

- DO NOT USE phenolic germicidal detergent solutions on any parts of the device. Contact Teladoc Health Technical Support or see above for approved cleaning solutions.
- Severe contamination may require some disassembly, and this should only be done by a Teladoc Health representative.
- DO NOT IMMERGE the device.
- DO NOT ALLOW any cleaning solution inside the device.
- Keep the device from moisture and extreme temperatures.
- Avoid excess solution that could enter the device through its openings.

WARNINGS:

- Do not attempt to open or remove any parts of the TV Pro 300 Cart.
N'essayez pas d'ouvrir ou de retirer des pièces du TV Pro 300 Cart.
- Do not remove any covers to reduce the risk of electric shock. There are no user-serviceable components inside.
Ne retirez aucun couvercle afin de réduire le risque d'électrocution. Il n'y a aucun composant réparable par l'utilisateur à l'intérieur.
- Wear safety glasses when handling solution prior to dilution.
Portez des lunettes de sécurité lorsque vous manipulez la solution avant la dilution.
- Wear rubber or nitrile gloves if in contact with liquid.
Portez des gants en caoutchouc ou en nitrile en cas de contact avec du liquide.
- Avoid contact with eyes, skin and clothing.
Évitez tout contact avec les yeux, la peau et les vêtements.
- Wash hands after cleaning device.
Lavez-vous les mains après avoir nettoyé l'appareil.
- Do not wear product-contaminated clothing for prolonged periods.
Ne portez pas de vêtements contaminés par des produits pendant de longues périodes.
- Always follow manufacturer's instructions on product labels when mixing chemicals.
Suivez toujours les instructions du fabricant sur les étiquettes des produits lorsque vous mélangez des produits chimiques.
- Ensure a power cord is connected to the AC wall outlet with protective earthing connection.
Assurez-vous qu'un cordon d'alimentation est branché dans une prise murale c.a. dotée d'une mise à la terre. Cordon d'alimentation branché à une prise de courant avec mise à la terre.

TV Pro 300 Cart Specifications

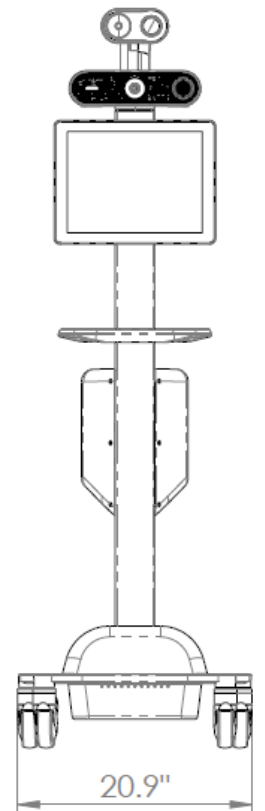
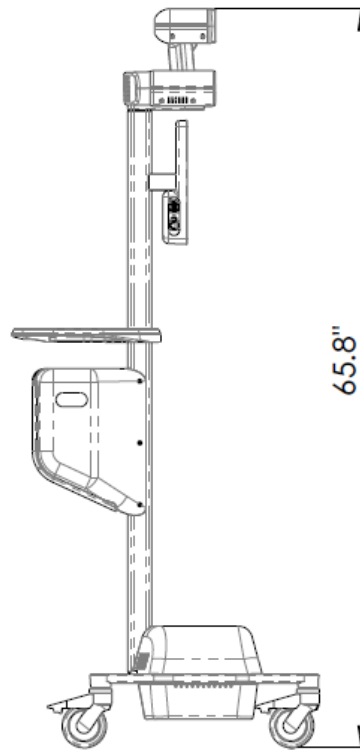
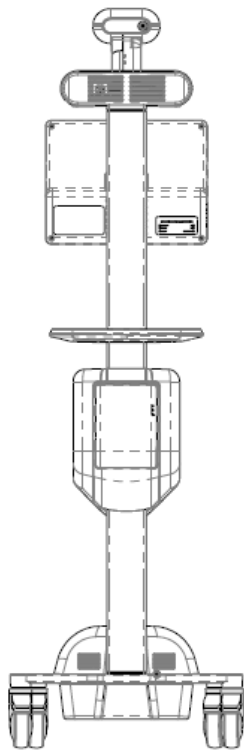
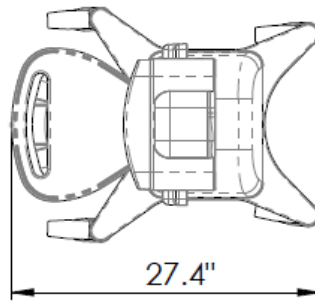

Weight: 66 lb

TV Pro 300 Cart Performance Specifications

Audio	Directional Microphone: For focused conversation Linear Array Microphone: For voice control Speaker: 20W full-range speaker
Camera	Fixed Camera: High Definition (HD), 3.5x Digital Zoom, 30 fps, 1080p Pan-Tilt-Zoom Camera: High Definition (HD), 20x Optical + 3.5x Digital Zoom, 30 fps, 1080p
USB Ports	2x USB 3.2 ports intended for hospital IT to service the device for maintenance purposes Each Port Output Power: 4.5W (5V DC x 0.9A)
Wireless Network	Wi-Fi 802.11 ac/a/b/g/n Bluetooth 4.1
Wired Network	1x Gigabit Ethernet
Service Life-cycle	8 years at minimum
Display	15" LCD, 1024 x 768 px, 500 nit, projected capacitive touch-screen.
Battery Life	8 hours depending on use
Charging	3 hours to fully charged

TV Pro 300 Cart Input Power Specifications

Voltage	100-240 VAC
Frequency	50/60 Hz
Current	6.5 A

TV Pro 300 Cart Environmental Specifications

Operating:

Designed to operate in an indoor environment suitable for human personnel. (10° to 35° C, 30% to 75% RH, 700 hPa to 1,013 hPa) from 0 to 10,000 ft (3,048 m)

Non-operating:

Designed to travel to installations in commercial and cargo airliners and standard ground transportation. (0° to +50° C, 10% to 95% RH, 700 hPa to 1,013 hPa) from 0 to 10,000 ft (3,048 m)

RF Power Rating and Frequencies

Bluetooth Dongle

- RF power is <2 dBm, and the distance between antenna and human is >1 mm separation, thus TV Pro 300 remote control does not need to be tested to SAR standard
- RF operating frequency: 2402-2480 MHz

Intel AX210 on i3 Board

- RF power is <20 dBm.
- RF operating frequency: 2400-2483.5 MHz, 5150-5350 MHz, 5470-5725 MHz, 5745-5825 MHz

TV Pro 300 Cart Electrical and Safety Test Standards

Electrical Equipment Test Standards

Standard Category	Standard field	Certificate	Detail Standards
IT	EMC/RF	FCC	Video system: FCC part 15.247, 15.407 part2.1091 Part 15B Remote control: FCC part 15.247 part2.1093
IT	EMC/RF	IC	RSS-247, RSS-102 For class A digital device: CAN ICES-003 (A) / NMB-3 (A)
Medical	EMC	EMC CNAS test report only (for audio system & remote control)	IEC 60601-1-2:2014/AMD1:2020 EN 60601-1-2:2015/A1:2021 CISPR 11:2015+AMD1:2016+AMD2:2019 EN 55011:2016/A2:2021
Medical	Safety	Safety test report	IEC60601-1:2005+A1:2012+A2:2020 EN60601-1:2006+A1:2013+A12:2014+A2:2021

1. RED: Radio Equipment directive 2014/53/EU
2. ErP: Energy-Related Products
3. NRTL: Nationally Recognized Testing Laboratory

Contact Information

24/7 Live Technical Support

1-877-484-9119

24/7 Live Remote Technical Support & Live Chat

<https://teladochealth.com/contact>

Email Support

tac@teladochealth.com

Teladoc Health User Manuals

<https://solosupport.teladochealth.com/>

Sales & Product Demos

1-805-562-8686



Teladoc Health
7406 Hollister Avenue, Goleta, CA 93117
Ph: +1.805.562.8686 • Fax: +1.805.562.8663



[Learn More](#)

TeladocHealth.com | engage@teladochealth.com

About Teladoc Health

Teladoc Health is the global virtual care leader, helping millions of people resolve their healthcare needs with confidence. Together with our clients and partners, we are continually modernizing the healthcare experience and making high-quality healthcare a reality for more people and organizations around the world.

© Teladoc Health, Inc. All rights reserved.

Teladoc[®]
HEALTH